



 **AKRO-MILS<sup>®</sup>**



[akro-mils.com](http://akro-mils.com)

Materials...  
**Handled!**<sup>™</sup>



# Table of Contents

## Storage Bins – Hanging & Stacking.....04-10

04 AkroBins	07 1800 Series AkroBins	08 Super-Size AkroBins
06 InSight Bins	07 ESD AkroBins	10 Stak-N-Store Bins

## Labeling ..... 11

11 Labels & Card Holders	11 Extended Label Holder	11 Angle•Vu
--------------------------	--------------------------	-------------

## Storage Bins – Shelf Style.....12-16

12 Shelf Bins	14 Indicator Bins	16 System Bins
13 ShelfMax Bins	15 AkroDrawers	16 Economy Bins

## Heavy-Duty Totes & Containers.....17-25

17 Akro-Tub, Cross-Stack Akro-Tub	19 KeepBox	24 Multi-Load Tote
18 Attached Lid Containers	20 Nest & Stack Totes (NST)	25 Straight Wall Containers (SWC)
	22 Akro-Grid	

## Bin Hanging Systems & Racks.....26-33

26 Rail Hanging Systems	30 AkroShelf	31 Benchtop Spinner Racks
28 Louvered Panels	31 Louvered Bench Racks	32 Pick Racks

## Small Parts Storage.....34-35

34 Storage Cases	35 Portable Organizer	35 Tote Caddy
34 Utility Boxes	35 ProBox Toolboxes	

## Cabinets .....36-44

36 TiltView Bins	39 Mobile Rack	44 Standard Bin Cabinets with Quick-View Door
38 19-Series Steel Cabinets	40 Plastic Cabinets	
39 Storage-Go-Round	42 Standard Bin Cabinets	

## Shelving Systems .....45-54

45 Wire Shelving Components	48 Wire Shelving Systems	51 Steel Shelving Systems
-----------------------------	--------------------------	---------------------------

## Dollies ..... 55

55 Steel Dollies
------------------

## Platform Trucks .....56-57

56 VERSA/Deck	57 ULTRA/Deck
---------------	---------------

## Carts & Hand Trucks.....58-61

58 ProCart	60 Medium-Duty Hand Truck	61 Pail Truck
60 Heavy-Duty Hand Truck	60 Gas Cylinder Truck	

## Bulk Handling .....62-64

62 Akro-Tilt Trucks	64 Akro-Carts
---------------------	---------------

## Caster Descriptions ..... 65

## Index .....66-67

# Materials... Handled!™

Look for this logo  throughout our catalog to find products that feature demonstration videos on [akro-mils.com](http://akro-mils.com)!



# Table of Contents

							
<b>04</b> AkroBins	<b>06</b> InSight Bins	<b>07</b> 1800 Series AkroBins	<b>07</b> ESD AkroBins	<b>08</b> Super-Size AkroBins	<b>10</b> Stak-N-Store	<b>11</b> Card Stock Holders	<b>11</b> Angle•Vu Label Holder
							
<b>12</b> Shelf Bins	<b>13</b> ShelfMax Bins	<b>14</b> Indicator Bins	<b>15</b> AkroDrawers	<b>16</b> System Bins	<b>16</b> Economy Bins	<b>17</b> Akro-Tubs : Cross-Stack Akro-Tubs	<b>18</b> Attached Lid Containers
							
<b>19</b> KeepBoxes	<b>20</b> Nest & Stack Totes	<b>22</b> Akro-Grids	<b>24</b> Multi-Load Totes	<b>25</b> Straight Wall Containers	<b>26</b> Rail Hanging Systems	<b>28</b> Louvered Panels : Louvered Racks	<b>30</b> AkroShelf
							
<b>31</b> Louvered Bench Racks	<b>31</b> Benchtop Spinner Racks	<b>32</b> Pick Racks	<b>34</b> Storage Cases	<b>34</b> Utility Boxes	<b>35</b> Portable Organizers	<b>35</b> Toolboxes	<b>35</b> Tote Caddy
							
<b>36</b> TiltView Bins	<b>38</b> 19 Series Steel Cabinets	<b>39</b> Storage-Go-Round	<b>39</b> Mobile Rack	<b>40</b> Plastic Cabinets	<b>42</b> Standard Cabinets - Solid Door	<b>44</b> Standard Cabinets - Quick-View Door	<b>45</b> Wire Shelving Components
							
<b>47</b> Wire Shelving Starter Units	<b>48</b> Wire Shelving Systems	<b>51</b> Steel Shelving Systems	<b>55</b> Steel Dollies	<b>56</b> VERSA/Deck	<b>57</b> ULTRA/Deck	<b>58</b> ProCart	<b>60</b> Hand Trucks
							
<b>60</b> Gas Cylinder Trucks	<b>61</b> Pail Trucks	<b>62</b> Akro-Tilt	<b>64</b> Akro-Cart	<b>65</b> Caster Information	<b>66</b> Index		



# AkroBins®

## INDUSTRY-LEADING HANGING & STACKING BINS



### FEATURES

- 1 Anti-slide stop prevents stacked bins from shifting forward
- 2 Optional dividers allow you to create customizable compartment sizes
- 3 Full-width hanger lip supports bin on hanging system
- 4 Curved-bottom hopper front makes it easy to retrieve small parts
- 5 Reinforced side ribs add strength and prevent spreading when stacked
- 6 Large front label area for easy coding and scanning
- 7 Extra-wide stacking ledge provides stability, saves space and prevents spills



### PRODUCT HIGHLIGHTS

- **EFFICIENT** – Control inventories, shorten assembly times, minimize parts handling
- **FUNCTIONAL** – Heavy-duty bins securely stack atop each other, sit on shelving, and hang from Akro-Mils racks, panels, rails and carts
- **DURABLE** – Molded of industrial-grade polymers, AkroBins are resistant to weak acids and alkalis. Water, rust and corrosion-proof
- **VARIETY** – Available in 15 sizes and 7 Standard Colors: Red, Blue, Yellow, Stone, Green, Black and Clear! Other colors available in minimum quantities
- **GUARANTEED** – AkroBins are guaranteed not to crack or break under normal load conditions as stated in our 1-year limited warranty



### STANDARD COLORS

Red, Yellow, Blue, Stone, Green, Clear, Black



### SPECIALTY COLORS

Light Blue, Purple





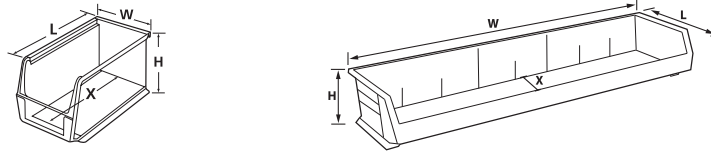

AkroBins		Outside Dimensions (In.)			Bottom Dimensions (In.)				Capacity/Quantity		Accessories					
Model No.	In Stock Colors <small>Other Colors Require Minimum Qty.</small>	L	W	H	L	W	H	X	Bin Load Capacity On Rack	Bin Ctn. Qty.	Black Length Dividers‡	Black Width Dividers‡	Divider Pkg. Qty.	Bin Lids	Lid Pkg. Qty.	Card Stock
30210	R, Y, B, S, G, SC, K	5-3/8	4-1/8	3	4-3/4	3-7/16	2-13/16	4	10 lbs.	24	40210 (1)	-	6	30211CRY	24	29301
30220	R, Y, B, S, G, SC, K	7-3/8	4-1/8	3	6-3/4	3-7/16	2-13/16	6	10 lbs.	24	40220 (1)	-	6	30221CRY	24	29301
30237	R, Y, B, S, G, SC, K	9-1/4	6	5	8-9/16	4-7/8	4-3/4	7-1/4	20 lbs.	12	40237 (1)	-	6	-	-	29302
30224	R, Y, B, S, G, SC, K	10-7/8	4-1/8	4	10-1/4	3-3/16	3-3/4	9	20 lbs.	12	40224 (1)	-	6	30225CRY	12	29301
30230	R, Y, B, S, G, SC, K, LTBLU, PUR	10-7/8	5-1/2	5	10-1/4	4-3/8	4-3/4	9	30 lbs.	12	40230 (1)	41230 (3)	6	30231CRY	12	29302
30234	R, Y, B, S, G, SC, K	14-3/4	5-1/2	5	14-1/16	4-3/8	4-3/4	12-13/16	50 lbs.	12	40234 (1)	-	6	-	-	29302
30239	R, Y, B, S, G, SC, K	10-7/8	8-1/4	7	10	6-9/16	6-3/4	8	50 lbs.	6	40239 (1)	-	6	-	-	29302
30240	R, Y, B, S, G, SC, K, LTBLU, PUR	14-3/4	8-1/4	7	14	6-9/16	6-3/4	12	60 lbs.	12	40245 (1)	-	6	-	-	29302
30265	R, Y, B, S, G, SC, K	18	8-1/4	9	17-1/8	6-3/4	8-1/4	14-1/2	60 lbs.	6	40265 (1)	-	6	-	-	-
30235	R, Y, B, S, G, SC, K, PUR	10-7/8	11	5	10-1/4	10	4-3/4	9	50 lbs.	6	40230 (3)	-	6	30236CRY	6	29302
30260	R, Y, B, S, G, SC, K	18	11	10	17	9-1/2	9-3/4	14-3/16	60 lbs.	6	40260 (3)	-	6	-	-	-
30255	R, Y, B, S, G, SC, K	10-7/8	16-1/2	5	9-3/4	15	4-3/4	9	60 lbs.	6	40230 (3)	-	6	-	-	29302
30250	R, Y, B, S, G, SC, K, LTBLU, PUR	14-3/4	16-1/2	7	14	14-3/4	6-3/4	12	75 lbs.	6	40245 (3)	41250 (3)	6	-	-	29302
30270	R, Y, B, S, G, SC, K	18	16-1/2	11	17-1/8	14-3/4	10-1/4	14	75 lbs.	3	40270 (3)	41270 (3)	6	-	-	-
30320	B	8-5/8	33	5	7	31-1/2	4-3/16	6	80 lbs.	4	40321 & 40220 (7)	-	7/6	-	4	-

Order in carton quantities. One color per carton. Specify Red, Yellow, Blue, Stone, Green, Clear, Black, Light Blue, Purple. Other colors available, minimum quantities apply. CAUTION: When using bins with hanging systems, do not exceed the weight capacity for the rack, which may be less than the total sum of bin capacities. 40321=Full Divider; 40220=Short Divider. †( ) = Max. # of divider slots per bin. Bin color code: R=Red, Y=Yellow, B=Blue, S=Stone, G=Green, SC=Clear, K=Black, LTBLU=Light Blue, PUR=Purple.

## ACCESSORIES



**Length Dividers**  
Keep items separated in bin.



**See-Through Crystal Clear Lids**  
Keep contents dust-free and protected



**Width Dividers**  
Available for 30230, 30250 and 30270

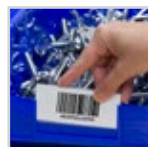

**Card Stock Holders**  
Clearly identify the bin's contents. (See page 11)

Card Stock Model No.	W	H
29301	3	1
29302	4	1-3/4



The 30237 fits perfectly on 18" deep shelving to form a two-bin Kanban system.

## RELATED PRODUCTS

Create the perfect storage system – mix and match your selection of AkroBins with compatible products



**26-27** Rail Hanging Systems



**28-32** Louvered Hanging Systems



**41-44** Bin Cabinets



**48-51** Wire Shelving Systems



**58** ProCart



# InSight®

## ULTRA-CLEAR POLYCARBONATE BINS

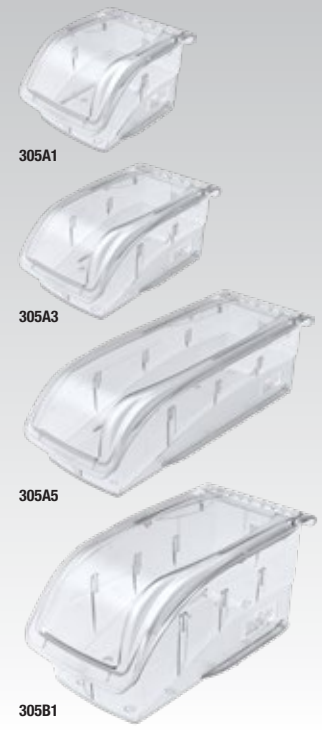

### FEATURES

- 1 Unique “lock-in-place” design for secure stacking
- 2 Strong molded hanger supports bins on hanging systems
- 3 Large label area for part identification and bar code scanning
- 4 Optional lids (sold separately) protect contents from dust. Will stack with lids in place



**COLOR**  
Clear



### PRODUCT HIGHLIGHTS

- **VISIBILITY** – Bins provide easy and maximum visibility of parts and supplies
- **FUNCTIONAL** – Bins securely stack, and hang from louvered panels, rails or racks
- **NO-TIP FEATURE** – Patent-pending design: Bins won't tip when stacked!
- **DURABLE** – Products made of high-impact polycarbonate are autoclavable up to 250° F
- **VARIETY** – Available in 4 sizes



InSight Model No.	Outside Dimensions (In.)			Inside Dimensions (In.)			Capacity/Quantity		Accessories	
	L	W	H	L	W	H	Capacity (lbs.)	Bin Ctn. Qty.	Lid	Lid Pkg Qty.
305A1	5-3/8	4-1/8	3-1/4	4-1/4	3-1/8	2-5/8	10	16	305A2	16
305A3	7-3/8	4-1/8	3-1/4	6-1/4	3-1/8	2-5/8	10	16	305A4	16
305A5	10-7/8	4-1/8	3-1/4	9-1/4	3-1/8	2-5/8	15	12	305A6	12
305B1	10-7/8	5-1/2	5-1/4	9-7/16	4-1/8	4-7/16	25	12	305B2	12

Order in carton quantities.

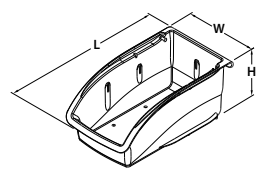

### ACCESSORIES



**Lids**  
Protect bin contents from dust



# 1800 Series AkroBins® : ESD Containers

## SPECIALTY AKROBINS

800.253.2467  
akro-mils.com

STORAGE BINS -  
HANGING & STACKING

## 1800 Series AkroBins®

### STACKABLE SHELF BINS



- **DURABLE** – Strong industrial-grade polymer construction
- **STACKING** – Stackable storage systems for large, heavy or bulky items
- **DIVIDABLE** – One black width divider included per bin



30348

**COLOR**  
Beige



1800 Series	Outside Dimensions (In.)			Inside Dimensions (In.)							
Model No.	L	W	H	L	W	H	X	Ctn. Qty.	Dividers	Pkg. Qty.	Capacity (Lbs.)
30348BEIGE	20-1/2	8-1/4	7	20	7-3/8	6-1/2	20	6	40348 (3)	6	60
30358BEIGE	20-1/2	11	7	20	10-1/8	6-1/2	20	6	40358 (3)	6	75

Available in Beige. Order in carton quantities.

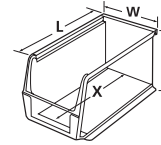

## ESD Containers

### AKROBINS MADE WITH ELECTROSTATIC DISSIPATIVE MATERIALS



- **PROTECTION** – Dissipate electrostatic charges, which can severely damage sensitive electronic components
- **OHM RATING** – Static Dissipative Range  $10^4$  to  $10^{11}$  ohms/sq.
- **LOW CARBON** – 1% - 2% carbon content - won't leave residue on parts



30235ESD



**COLOR**  
Black



ESD Containers	Outside Dimensions (In.)			Inside Dimensions (In.)					
Model No.	L	W	H	L	W	H	X	Cap. on Rack	Ctn. Qty.
30210ESD	5-3/8	4-1/8	3	4-3/4	3-7/16	2-13/16	4	10 lbs.	24
30220ESD	7-3/8	4-1/8	3	6-3/4	3-7/16	2-13/16	6	10 lbs.	24
30230ESD	10-7/8	5-1/2	5	10-1/4	4-3/8	4-3/4	9	30 lbs.	12
30235ESD	10-7/8	11	5	10-1/4	10	4-3/4	9	50 lbs.	6
30240ESD	14-3/4	8-1/4	7	14	6-9/16	6-3/4	12	60 lbs.	12

Available in Black. Order in carton quantities.

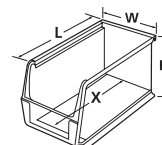

30210ESD  
30220ESD



# Super-Size AkroBins®

INDUSTRY-LEADING LARGE-CAPACITY STACKING BINS



30292

MADE IN THE USA



5



## FEATURES

- 1 Reinforced side ribs add strength and prevent spreading when stacked
- 2 Anti-slide stop prevents stacked bins from shifting forward
- 3 Large label area on front of bin
- 4 Divider slots help create separate compartments
- 5 Easy to carry with large handle molded onto back of bin

## PRODUCT HIGHLIGHTS

- **CAPACITY** – Large-capacity storage to improve organization and workflow
- **STACKABLE** – Heavy-duty bins securely stack on top of each other, sit on shelving, carts or dollies
- **DURABLE** – Molded of industrial-grade polymers, Super-Size AkroBins are resistant to weak acids and alkalis. Water, rust and corrosion-proof
- **VARIETY** – Available in 12 sizes and 5 colors: Red, Blue, Yellow, Gray and Clear
- **GUARANTEED** – Super-Size AkroBins are guaranteed not to crack or break under normal load conditions as stated in our 1-year limited warranty

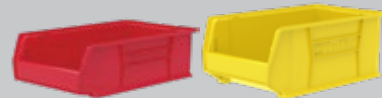

30280

30281



30282

30283

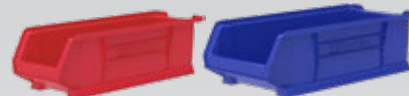

30284

30286



30287

30288



30289



30290



30292



30293

## COLORS

Red, Yellow, Blue, Gray, Clear





# Super-Size AkroBins®

## INDUSTRY-LEADING LARGE-CAPACITY STACKING BINS

800.253.2467  
akro-mils.com

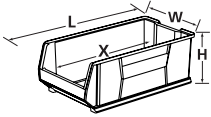

Super-Size AkroBins Model No.	Outside Dimensions (In.)			Inside Dimensions (In.)				Capacity/Quantity			Accessories		
	L	W	H	L	W	H	X	Max. Cap. per Bin	Stacking Cap./= Qty. Stacked	Ctn. Qty.	Width Dividers*	Length Dividers*	Divider Pkg. Qty. W L
30280	20	12-3/8	6	16-7/8	10-11/16	5-3/8	15-1/2	200 lbs.	40 lb./10	4	–	40280 (3)	– 2
30281	20	12-3/8	8	16-7/8	10-11/16	7-3/8	15-1/2	200 lbs.	50 lb./7	3	–	40281 (3)	– 3
30282	20	12-3/8	12	16-7/8	10-11/16	11-3/8	15-1/2	200 lbs.	60 lb./5	2	–	40282 (3)	– 1
30283	20	18-3/8	12	16-7/8	16-9/16	11-3/8	15-1/2	300 lbs.	150 lb./5	1	–	40282 (3)	– 1
30284	23-7/8	8-1/4	7	20-7/8	6-3/8	6-1/8	19-3/8	200 lbs.	150 lb./5	4	41284 (2)	40286 (1)	2 4
30286	23-7/8	11	7	20-7/8	9-1/8	6-1/8	19-5/16	200 lbs.	150 lb./5	4	41286 (2)	40286 (3)	2 4
30287	23-7/8	11	10	20-3/4	9	9-1/8	19-5/16	300 lbs.	150 lb./5	4	41287 (2)	40287 (3)	6 6
30288	23-7/8	16-1/2	11	20-3/4	14-3/8	10-1/8	19-5/16	300 lbs.	150 lb./5	1	41288 (2)	40287 (3)	6 6
30289	23-7/8	18-1/4	12	20-3/4	16	11-1/8	19-1/4	300 lbs.	150 lb./5	1	41289 (2)	–	2 –
30290	29-1/4	18-3/8	12	26-1/8	16-9/16	11-3/8	24-3/4	300 lbs.	150 lb./5	1	–	40290 (3)	– 1
30292	29-7/8	11	10	26-3/4	9	9-1/8	25-5/16	300 lbs.	150 lb./5	4	41287 (2)	40292 (3)	6 6
30293	29-7/8	16-1/2	11	26-3/4	14-3/8	10-1/8	25-5/16	300 lbs.	150 lb./5	1	41288 (2)	40292 (3)	6 6

Order in carton quantities. One color per carton: Specify Red, Blue, Yellow, Clear or Gray. Not recommended to hang on rack or panel systems. \* ( ) = Max. # of divider slots per bin.

### ACCESSORIES



**Length Dividers**  
Available for 11 sizes



**Width Dividers**  
Available for 7 sizes



### RELATED PRODUCTS

Increase the benefits of your Super-Size AkroBins with the following products



48-50 Wire Shelving Systems



51-54 Steel Shelving Systems



# Stak-N-Store Bins

STACKABLE BINS PERFECT FOR HEAVY, BULKY ITEMS



**STANDARD COLORS**  
Blue, Clear, Gray

**NON-STANDARD COLOR<sup>‡</sup>**  
Red

‡Minimum quantities apply.



## FEATURES

- 1 Large radius corners and rolled rim add strength
- 2 Side ribs add stability when stacked
- 3 Wide hopper front allows easy access to bulky items
- 4 Large comfort grip handles

## PRODUCT HIGHLIGHTS

- **STACKBLE** – Bins stack to form tall, stable storage arrangements on floors or standard industrial shelving
- **CAPACITY** – 75-lb. weight capacity
- **DURABLE** – Industrial-grade polymer will not rust, corrode or bend out of shape even when fully loaded
- **COST-EFFECTIVE** – Longer service life resulting in lower replacement costs
- **VARIETY** – Available in 3 sizes and 3 colors: Blue, Gray, Clear. Available in Red, minimum quantities apply



Stak-N-Store Bins Model No.	Outside Dimensions (In.)			Inside Dimensions (In.)				Capacity/Quantity				
	L	W	H	L	W	H	X	Cu. Ft.	Gal	Lbs.	Stacking Height	Ctn. Qty.
13014	17-1/2	10-7/8	12-1/2	15-5/8	8	12-1/4	13-1/2	.98	7.4	75	3	4
13017	15-1/4	19-7/8	12-7/16	13-5/8	17-1/2	12-1/4	11-1/2	1.7	12.7	75	3	3
13018	17-1/2	16-1/2	12-1/2	15-5/8	13-3/4	12-1/4	13-1/2	1.6	12	75	3	2

Order in carton quantities. One color per carton. Specify Blue, Gray or Clear. Also available in Red, minimum quantities apply.

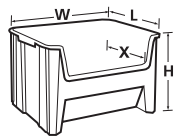

## RELATED PRODUCTS

Add mobility to your Stak-N-Store Bins with



48-50 Wire Shelving Systems



51-54 Steel Shelving Systems

# Labeling Options

FOR BINS, TOTES, CONTAINERS AND WIRE SHELVING

800.253.2467  
akro-mils.com

## Card Stock Holders

CARD STOCK WITH PROTECTIVE PLASTIC HOLDER



Card Stock Holder	Dimensions (In.)		Works With:	Cards Per Sheet	Sheets Per Pack	Total Cards Per Pack	Total # of Clear Holders
Model No.	W	H					
29300	3	13/16	All 4" Shelf Bins**	24	3	72	25
29301	3	1	30210, 30220, 30224, AkroBins; All ShelfMax Bins	20	3	60	25
29302	4	1-3/4	30230, 30234, 30235, 30239, 30240, 30250, 30255, 30348, 30358 AkroBins	12	3	36	25

The clear holders for the 29300 - 29302 fit in our card slot holder. \*\*Excluding 30110 (29300 can be cut to length) 1%.

## Extended Label Holder

CREATES LARGE LABEL AREA ON SHELF BINS



Extended Label Holders	Label Face Dimensions (In.)		Description	Ctn. Qty.
Model No.	W	H		
40410	4	2-3/8	Works with 4" Shelf Bins*, All 6" ShelfMax Bins	24

\*Does not work with 30110.

## Angle•Vu™ Adjustable Label Holder

NO MORE CLIMBING OR BENDING TO READ OR SCAN A LABEL!

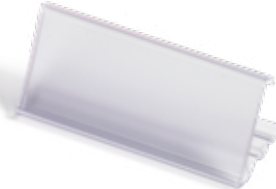

- **ADJUSTABLE** – Allows the label face to be pointed upward on low wire shelves and downward or flat on wire shelves at or above eye-level

Angle-Vu	Dimensions (In.)		Total No.			
Model No.	W	H	Cards Per Sheet	Sheets Per Pack	Cards Per Pack	Label Holders
29306	3	1-1/4	16	3	48	25

## Flat Label Holder

ATTACHES TO THE FACE OF WIRE SHELVING UNITS



Flat Label Holder	Dimensions (In.)		Total No.			
Model No.	W	H	Cards Per Sheet	Sheets Per Pack	Cards Per Pack	Label Holders
29308	3	1¼	16	3	48	25



# Shelf Bins

INDUSTRY-LEADING 4" HIGH SHELF BINS ARE DURABLE, EFFICIENT



## FEATURES

- 1 Wide hopper front allows easy access
- 2 Built-in rear hanglock allows bin to tilt out for complete access
- 3 Molded-in label area identifies contents
- 4 Each bin accepts up to 7 dividers (except 30110)
- 5 Works in temperatures down to -20° F

## PRODUCT HIGHLIGHTS

- **EFFICIENT** – Shelf Bins work with 12", 18" and 24" deep shelving, pick racks or vertical storage and retrieval units
- **DURABLE** – Industrial-grade polymer bins outlast corrugated bins – paying for themselves in reduced replacement costs. Bins won't spread or crack when loaded. One-piece construction is waterproof and resistant to grease or oil
- **NESTABLE** – Shelf Bins nest when empty to conserve space
- **VARIETY** – Available in 13 sizes and 5 colors: Red, Blue, Yellow, Green and Clear. Available in White, minimum quantities apply

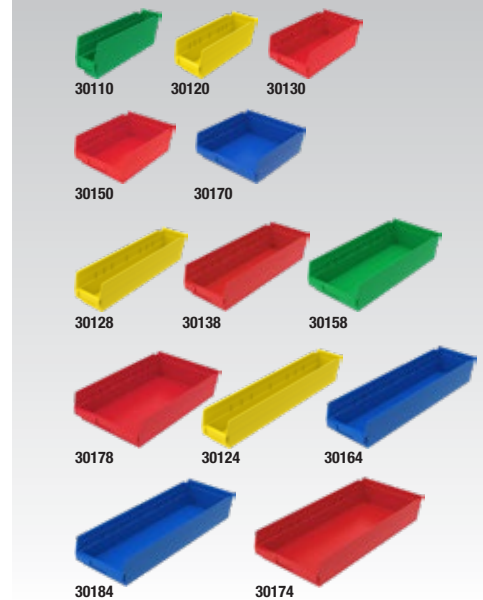

## STANDARD COLORS

Red, Yellow, Blue, Clear, Green



## NON-STANDARD COLOR‡

White



‡Minimum quantities apply.



Shelf Bins Model No.	Outside Dimensions (In.)			Inside Dimensions (In.)			Capacity/Quantity		Cups per Bin		Accessories		
	L	W	H	L	W	H	Cubic Inches	Ctn. Qty.	Small 30101	Large 30102	Width Dividers*	Divider Pkg. Qty.	Card Stock
30110	11-5/8	2-3/4	4	10-1/4	1-5/8	4	54	24	3	–	–	–	29300**
30120	11-5/8	4-1/8	4	10-1/4	3	4	78	24	5	2	40120 (7)	24	29300
30130	11-5/8	6-5/8	4	10-1/4	5-1/2	4	128	12	9	4	40130 (7)	24	29300
30150	11-5/8	8-3/8	4	10-1/4	7-1/8	4	138	12	11	4	40150 (7)	24	29300
30170	11-5/8	11-1/8	4	10-1/4	10	4	197	12	15	6	40170 (7)	24	29300
30128	17-7/8	4-1/8	4	16-1/2	3	4	123	12	8	3	40120 (7)	24	29300
30138	17-7/8	6-5/8	4	16-1/2	5-1/2	4	176	12	15	6	40130 (7)	24	29300
30158	17-7/8	8-3/8	4	16-1/2	7-1/8	4	214	12	15	6	40150 (7)	24	29300
30178	17-7/8	11-1/8	4	16-1/2	10	4	292	12	25	12	40170 (7)	24	29300
30124	23-5/8	4-1/8	4	22-1/8	3	4	199	12	11	4	40120 (7)	24	29300
30164	23-5/8	6-5/8	4	22-1/8	5-1/2	4	321	6	21	8	40130 (7)	24	29300
30184	23-5/8	8-3/8	4	22-1/8	7-1/8	4	346	6	25	8	40150 (7)	24	29300
30174	23-5/8	11-1/8	4	22-1/8	10	4	513	6	35	16	40170 (7)	24	29300

Order in carton quantities. One color per carton: Specify Red, Blue, Yellow, Green or Clear. Also available in White, minimum quantities apply. \* ( ) = Max. # of divider slots per bin. \*\*29300 must be cut to length to fit 30110.

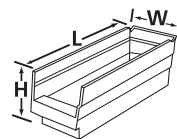

## ACCESSORIES



**Bin Cups**  
Lift out easily for parts retrieval (see chart)



**Width Dividers**  
Available for all sizes (except 30110)

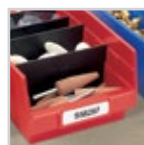

**Card Stock Holders**  
Card stock holders fit in bins' existing slot. (See page 11)



**Extended Label Holder**  
Slips into bins' label slot, creates extra large label area. (See page 11)

Bin Cups Model No.	Outside Dimensions (In.)			Ctn. Qty.
	L	W	H	
30101	2	3-1/4	3	48
30102	2-3/4	5	3	24





# ShelfMax® Bins

6" HIGH SHELF BINS MAXIMIZE STORAGE CAPACITY

800.253.2467  
akro-mils.com

STORAGE BINS -  
SHELF STYLE

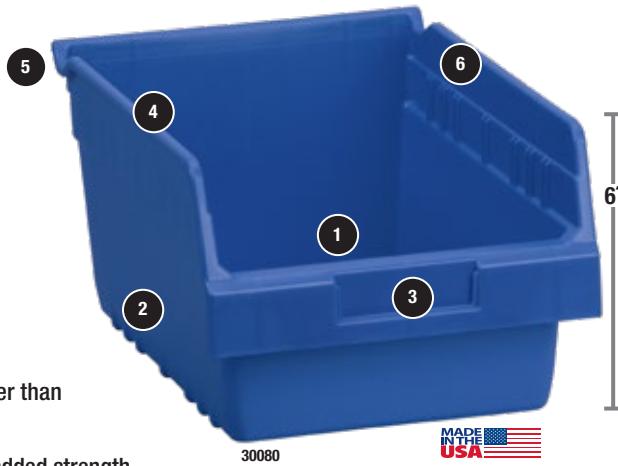

## FEATURES

- 1 Front opening is 3/4" higher than comparable 6" products
- 2 Reinforced side ribs for added strength
- 3 Large label area aids in part identification and bar code scanning
- 4 Rolled ridge provides added strength and durability when filled to capacity
- 5 Built-in rear hanglock allows bin to tilt out for complete access
- 6 Optional dividers create additional storage options

## PRODUCT HIGHLIGHTS

- **CAPACITY** – Bins offer 85% more storage than traditional 4" bins
- **EFFICIENT** – Works with steel shelving, wire shelving, pick racks and bench racks
- **DURABLE** – Superior construction compared to corrugated bins
- **VARIETY** – Available in 9 sizes and 3 colors: Red, Blue and Clear. Available in Yellow, minimum quantities apply

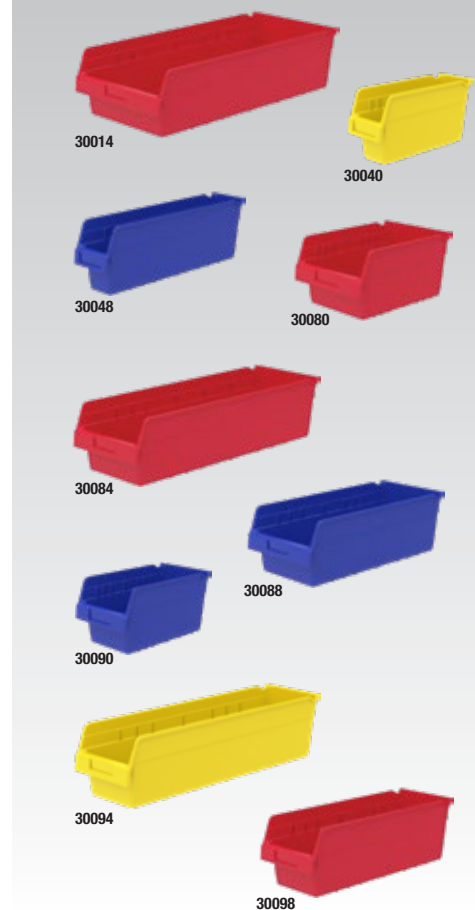

## COLORS

Red, Blue, Clear



## NON-STANDARD COLOR‡

Yellow



‡Minimum quantities apply.

ShelfMax Model No.	Outside Dimensions (In.)			Inside Dimensions (In.)			Capacity/Quantity		Accessories		
	L	W	H	L	W	H	Cubic Inches	Ctn. Qty.	Black Width Dividers*	Divider Pkg. Qty.	Card Stock
30040	11-5/8	4-1/8	6	9-3/4	2-1/2	5-15/16	175	16	40020 (7)	12	29301
30090	11-5/8	6-5/8	6	9-3/4	5	5-15/16	310	10	40030 (7)	12	29301
30080	11-5/8	8-3/8	6	9-3/4	6-5/8	5-15/16	398	8	40040 (7)	12	29301
30048	17-7/8	4-1/8	6	16	2-1/2	5-15/16	280	8	40020 (7)	12	29301
30098	17-7/8	6-5/8	6	16	5	5-15/16	505	10	40030 (7)	12	29301
30088	17-7/8	8-3/8	6	16	6-5/8	5-15/16	648	8	40040 (7)	12	29301
30094	23-5/8	6-5/8	6	21-3/4	5	5-15/16	686	10	40030 (7)	12	29301
30084	23-5/8	8-3/8	6	21-3/4	6-5/8	5-15/16	935	6	40040 (7)	12	29301
30014	23-5/8	11-1/8	6	21-3/4	9-1/2	5-15/16	1303	6	-	12	29301

Order in carton quantities. One color per carton: Specify Red, Blue or Clear. Also available in Yellow, minimum quantities apply. \* ( ) = Max. # of divider slots per bin.

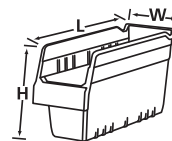

AVAILABLE IN  
**CLEAR**  
CFEUV



## ACCESSORIES



**Width Dividers**  
Available for 8 sizes



**Card Stock Holders**  
Card stock holders fit in bins' existing slot. (See page 11)



**Extended Label Holder**  
Slips into bins' label slot, creates extra large label area. (See page 11)



# Indicator® Bin

## TWO-TONE INVENTORY CONTROL BIN



### FEATURES

- 1 Bright orange/red trigger color shows low stock levels
- 2 Innovative double-hopper bin can be filled or picked from both sides
- 3 Large label area on both sides of bin
- 4 Rolled ridge provides added strength and durability
- 5 Width dividers (sold separately) used to separate reserve stock

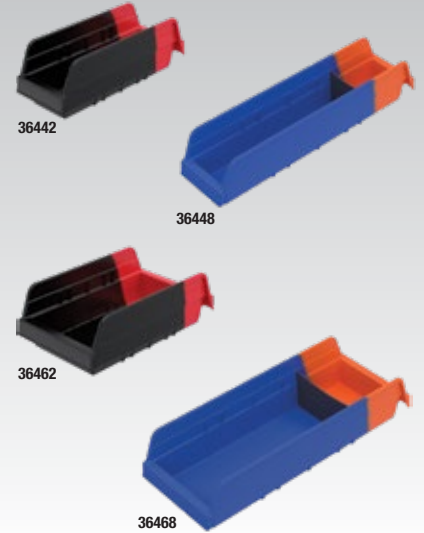
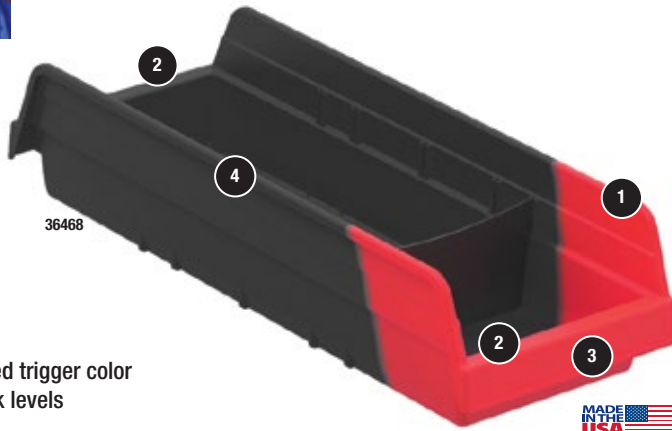

### COLORS

Blue/Orange, Black/Red



### PRODUCT HIGHLIGHTS

- **INVENTORY CONTROL** – Prevents stockouts with visual recognition when supplies need to be replenished
- **EASY TO USE:**
  - STOCK* – using the divider to designate volume for the inventory reserve
  - PICK* – from the blue/black side of the bin until you reach the divider
  - FLIP* – the bin to the orange/red reserve to show inventory levels are low
  - REPLENISH* – the bin and repeat!
- **VALUE** – Low-cost alternative to high-end inventory control systems



Stock Pick Flip Replenish



Indicator Bins		Outside Dimensions (In.)			Inside Dimensions (In.)			Accessories		
Model No.	Description	L	W	H	L	W	H	Bin Ctn. Qty.	Dividers*	Divider Pkg. Qty.
36442BLUE	Blue/Orange Bin	11-5/8	4-1/4	4	9-7/8	2-7/8	3-7/8	24	40120	24
36442BLKRED	Black/Red Bin	11-5/8	4-1/4	4	9-7/8	2-7/8	3-7/8	24	40120	24
36448BLUE	Blue/Orange Bin	17-7/8	4-1/8	4	16-1/8	2-3/4	3-7/8	12	40442	12
36448BLKRED	Black/Red Bin	17-7/8	4-1/8	4	16-1/8	2-3/4	3-7/8	12	40442	12
36462BLUE	Blue/Orange Bin	11-5/8	6-3/4	4	9-7/8	5-3/8	3-7/8	12	40130	24
36462BLKRED	Black/Red Bin	11-5/8	6-3/4	4	9-7/8	5-3/8	3-7/8	12	40130	24
36468BLUE	Blue/Orange Bin	17-7/8	6-5/8	4	16-1/8	5-1/4	3-7/8	12	40462	12
36468BLKRED	Black/Red Bin	17-7/8	6-5/8	4	16-1/8	5-1/4	3-7/8	12	40462	12

\*Dividers sold separately. Order in carton quantities.

### ACCESSORIES

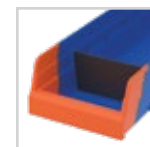

Width Dividers  
Available for  
all sizes

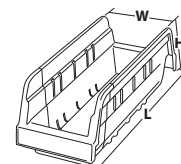

### RELATED PRODUCTS

Create the perfect storage solution – mix and match your Indicator Bins with these products



48-50 Wire Shelving Systems



51-54 Steel Shelving Systems



# AkroDrawers®

## HEAVY-DUTY STORAGE DRAWERS

800.253.2467  
akro-mils.com

STORAGE BINS -  
SHELF STYLE

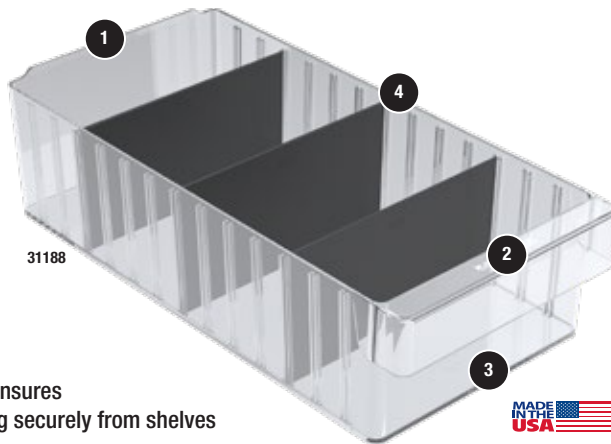

### FEATURES

- 1 Sturdy backstop tab ensures AkroDrawers can hang securely from shelves
- 2 Wide front handle for easy gripping when full or filled with heavy contents
- 3 Large label area for quick identification of parts
- 4 Multiple divider slots allow for customized storage solutions

### PRODUCT HIGHLIGHTS

- **PARTS PROTECTION** – AkroDrawers help keep your supplies, tools and parts secure and dust-free
- **FUNCTIONAL** – Drawers can be used with Akro-Mils' Pick Racks and Enclosed Steel Shelving
- **DURABLE** – Color drawers made of high-impact polystyrene; Crystal Clear drawers made of a durable acrylic blend
- **STACKABLE** – AkroDrawers can be stacked to optimize space
- **VARIETY** – Available in 8 sizes and 2 colors: Blue, Gray. Available in Red, Yellow, Crystal Clear, minimum quantities apply

## AkroDrawers®

AkroDrawers Model No.	Outside Dimensions (In.)			Inside Dimensions (In.)			Capacity/Qty.		Dividers*	Pkg. Qty
	L	W	H	L	W	H	Weight Capacity	Ctn. Qty.		
31142	11-5/8	3-3/4	4-5/8	10-1/4	3-1/16	4-7/16	15 lbs.	6	41440 (8)	6
31148	17-5/8	3-3/4	4-5/8	16-1/4	3-1/16	4-7/16	20 lbs.	6	41440 (13)	6
31162	11-5/8	5-9/16	4-5/8	10-1/4	4-7/8	4-7/16	20 lbs.	6	41460 (8)	6
31168	17-5/8	5-9/16	4-5/8	16-1/4	4-7/8	4-7/16	25 lbs.	6	41460 (13)	6
31182	11-5/8	8-3/8	4-5/8	10-1/4	7-5/8	4-7/16	20 lbs.	4	41480 (8)	6
31188	17-5/8	8-3/8	4-5/8	16-1/4	7-5/8	4-7/16	25 lbs.	4	41480 (13)	6
31112	11-5/8	11-1/8	4-5/8	10-1/4	10-7/16	4-7/16	25 lbs.	4	41410 (8)	8
31118	17-5/8	11-1/8	4-5/8	16-1/4	10-7/16	4-7/16	25 lbs.	4	41410 (13)	8

Order in carton quantities. Specify drawer color when ordering: Blue or Gray. Also available in Red, Yellow or Crystal Clear, minimum quantities apply. \*( ) = Max. # of divider slots per bin.

### ACCESSORIES



**Width Dividers**  
Available for  
all sizes

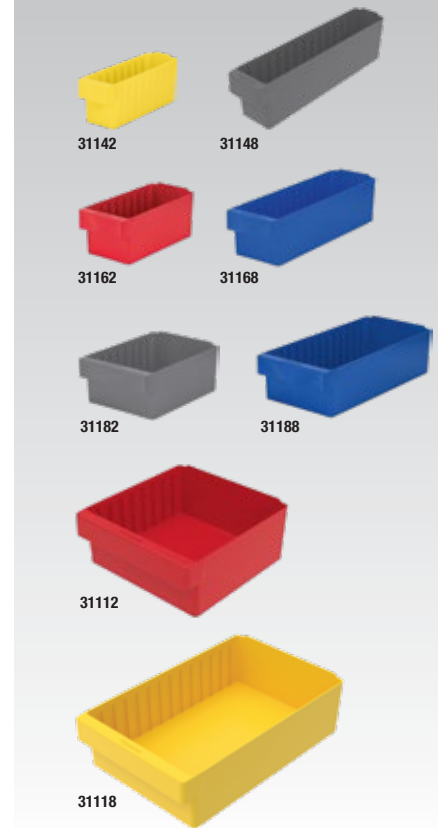

### STANDARD COLORS

Blue, Gray



### NON-STANDARD COLORS‡

Red, Yellow, Crystal Clear



‡Minimum quantities apply.

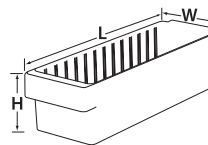

31168



# System Bins™ : Economy Bins

## NESTING / STACKING BINS

### System Bins™

SINGLE-PIECE,  
6-COMPARTMENT  
STORAGE UNIT

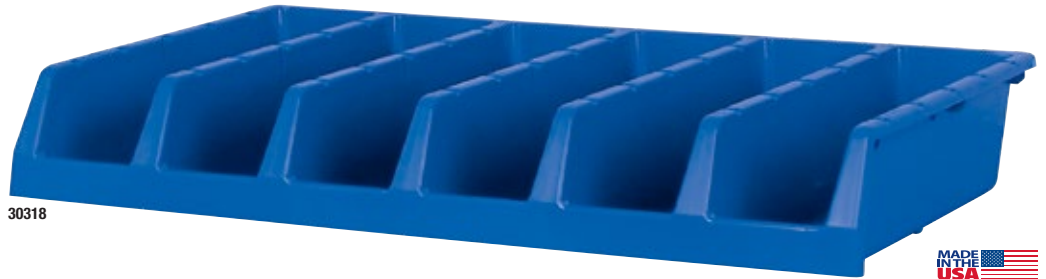

30318



### PRODUCT HIGHLIGHTS

- **SINGLE-PIECE** – Configured six-across in a single unit, 33" wide by 5" high; bins are sized to fit on 36" wide steel and wire shelving
- **VALUE** – A cost-effective alternative to flimsy, cardboard boxes
- **DURABLE** – Sturdy interior double-wall construction. One-piece, injection-molded
- **STACKABLE** – Can be safely stacked using a 3/8" wood dowel rod (not included)
- **NESTABLE** – Bins nest when empty to conserve space
- **VARIETY** – Available in 12" or 18" depths. Colors: Red, Yellow, Blue

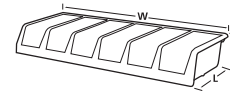

**COLORS**  
Red, Yellow, Blue



### SystemBins™

System Bins		Dimensions (In.)			Bin Compartment Dimensions (In.)*			Ctn. Qty.
Model No.	Description	L	W	H	L	W	H	
30312	12" System Bin	12	33	5	10-3/8	3-5/8	4-15/16	5
30318	18" System Bin	18	33	5	16-3/8	3-5/8	4-15/16	5

Order in carton quantities. One color per carton: Specify Red, Blue or Yellow. \*Bottom inside dimension per compartment.

### Economy Bins

#### NESTING & STACKING SHELF BIN



30716

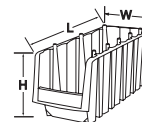

**COLOR**  
Black



- **VERSATILE** – Economy Bins make full use of shelf space on 12" or 18" deep shelving and stack to fill space between shelves
- **DURABLE** – Industrial-grade polymer construction
- **EXCLUSIVE** – The only small parts bin that can nest and stack
- **EFFICIENT** – Generous bin opening allows easy access to items

Economy Bins	Outside Dimensions (In.)			Inside Dimensions (In.)			Ctn. Qty.
Model No.	L	W	H	L	W	H	
30796BLACK	8-7/8	6-5/8	5	6-3/25	4	4-9/10	10
30716BLACK	11-7/8	6-5/8	5	9-3/25	4	4-9/10	10
30776BLACK	17-7/8	6-5/8	7	14-8/9	3-4/5	6-9/10	10
30718BLACK	11-7/8	8-3/8	5	9	5-3/4	4-9/10	8
30778BLACK	17-7/8	8-3/8	7	14-4/5	5-1/2	6-9/10	8

Order in carton quantities.





# Akro-Tubs

FOOD PROCESSING OR INDUSTRIAL TOTES

800.253.2467  
akro-mils.com



## FEATURES

- 1 Rolled top rim forms comfortable handles
- 2 Extra-thick walls for superior strength
- 3 Rounded corner design adds strength to stress points
- 4 Ribs prevent jamming when nested



## PRODUCT HIGHLIGHTS

- **SMOOTH SURFACE** – Easy to clean
- **NESTABLE** – Nests when empty to conserve space
- **FDA-COMPLIANT** – Tub manufactured from FDA-compliant materials

Akro-Tub Model No.	Outside Dimensions (In.)					Capacity/Qty.			
	L	W	H	A	B	Cu. Ft.	Gal.	Lbs.	Ctn. Qty.
34240	24-1/2	19	9-1/2	20-1/2	15-1/2	1.95	14.6	75	6

Order in carton quantities.

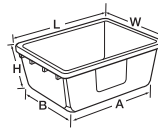

**COLOR**  
Gray



**NON-STANDARD COLOR†**  
Blue



†Minimum quantities apply.

## Cross-Stack Akro-Tubs



## FEATURES

- 1 Stacking grooves allow stable 90° stacks
- 2 Molded-in handles for easy lifting
- 3 Extra-thick walls and reinforcing ribs provide superior strength

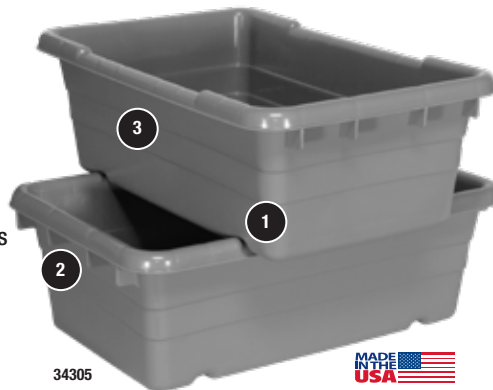

34305

## PRODUCT HIGHLIGHTS

- **FDA-COMPLIANT** – Tub manufactured from FDA-compliant materials
- **FUNCTIONAL** – Industrial-grade tub is compatible with standard 36" shelving and conveyor systems
- **NESTABLE** – Nesting when empty conserves storage space
- **STACKABLE** – Cross-stacking
- **SMOOTH SURFACE** – Easy to clean

Cross-Stack Akro-Tub		Outside Dimensions (In.)					Capacity/Qty.		
Model No.	Color	L	W	H	A	B	Cu. Ft.	Gal.	Ctn. Qty.
34301	Gray	17-1/4	11	8	13-1/4	7-3/4	0.52	3.85	6
34303	Gray	23-3/4	17-1/4	8	19-3/4	14	1.31	9.81	6
34304	Gray	23-3/4	17-1/4	12	19	13-1/4	1.92	14.38	6
34305	Gray	25	16	8-1/2	20-3/8	11-1/2	1.25	9.75	6

Order in carton quantities.

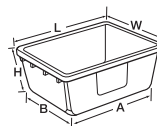

**COLOR**  
Gray





# Attached Lid Containers

## DISTRIBUTION CONTAINERS/STORAGE BOXES



### FEATURES

- 1 Textured bottoms provide a sure grip on conveyor belts
- 2 Strong molded-in handle grips are ergonomically designed for easy lifting and carrying
- 3 Padlock eye on both ends accommodate security ties
- 4 Reinforced hinge pins for years of smooth lid operation

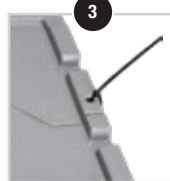

### STANDARD COLORS

Red, Blue, Green, Gray



### NON-STANDARD COLOR†

Clear



†Minimum quantities apply.

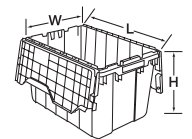

### PRODUCT HIGHLIGHTS

- **FUNCTIONAL** – Reusable shipping, distribution, order picking and storage containers
- **SECURE** – Attached lids snap securely closed to protect contents from dust and damage
- **STACKABLE and NESTABLE** – Containers stack on closed lids and nest in open lids
- **INTERWORKING** – Containers interwork for easy pallet loading
- **VARIETY** – 6 sizes and 4 colors. See the chart below for color options per model

Attached Lid Containers (ALCs)		Outside Dimensions (In.)			Inside Dimensions Top (In.)			Inside Dimensions Bottom (In.)		Capacity/Qty.					Accessories
Model No.	In Stock Colors Other Colors Require Minimum Qty.	L	W	H	L	W	H	L	W	Cu. Ft.	Gal.	Lbs.	Container Ctn. Qty.	Stack Cap./Qty. Stacked	Steel Dollies
39085	Blue, Gray	21-1/2	15-1/4	9	19-3/4	14-13/16	7-5/8	18-7/16	12-7/8	1.12	8.5	35	6	35 lbs./5	RU843HR1420
39120	Blue, Green, Red, Gray	21-1/2	15-1/4	12-1/2	19-3/4	14-13/16	12	17-7/8	12-3/8	1.62	12	65	6	65 lbs./5	RU843HR1420
39160	Gray	27	17	12-1/2	25	15-1/2	11-1/4	23-1/2	14	2.25	16.83	100	4	100 lbs./4	–
39170	Blue, Gray	21-1/2	15-1/4	17	19-3/4	14-13/16	15-3/4	17-7/8	12-3/8	2.28	17	100	3	100 lbs./3	RU843HR1420
39175	Gray	24	19-1/2	12-1/2	22	18	10-3/4	20-1/2	16-1/2	2.3	17.20	80	4	80 lbs./5	–
39280	Gray	28	21	15-1/2	26	19	14	25	18	3.82	28.57	100	2	100 lbs./4	–

One color per carton. Specify color: Red, Blue, Green or Gray. Order in carton quantities. Also available in Clear, minimum quantities apply.

# KeepBox™

## LIGHT DUTY STORAGE BOXES

800.253.2467  
akro-mils.com



66497CLDGN

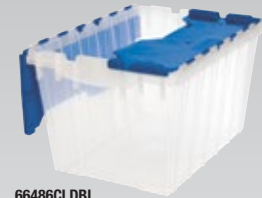

66486CLDBL



66486FILEB



66497CLDGN



### FEATURES

- 1 Clear sides allow visibility of contents
- 2 Attached lids won't get misplaced
- 3 Padlock eye on both ends accommodate security ties
- 4 Reinforced hinge pins for years of smooth lid operation
- 5 Hanging File KeepBox has metal rails for hanging letter-size folders

### COLORS

Blue/Clear, Green/Clear



### PRODUCT HIGHLIGHTS

- **FUNCTIONAL** – Secure, dust-free storage
- **NESTABLE** – Containers nest when empty



KeepBox Model No.	Description	Outside Dimensions (In.)			Inside Dimensions Top (In.)			Inside Dimensions Bottom (In.)		Capacity/Qty.				
		L	W	H	L	W	H	L	W	Cu. Ft.	Gal.	Lbs.	Ctn. Qty.	Stack Cap./Qty. Stacked
66486CLDBL	Clear 12 gal. KeepBox - Blue Lid	21-1/2	15	12-1/2	19-3/4	14-1/2	12	17-7/8	12-3/4	1.6	12	25	6	5
66486FILEB	Clear 12 gal. KeepBox - Blue Lid, Hanging File Rails	21-1/2	15	12-1/2	19-3/4	14-1/2	12	17-7/8	12-3/4	1.6	12	25	6	5
66497CLDGN	Clear 18 gal. KeepBox - Green Lid	21-1/2	15	17	19-3/4	14-1/2	15-3/4	17-7/8	12-3/4	2.3	17	35	3	4



Order in carton quantities.



# Nest & Stack Totes

EXTREMELY DURABLE INDUSTRIAL-GRADE TOTES



35200



## FEATURES

- 1 Smooth surfaces are easy to clean
- 2 Comfortable grip makes handling easy
- 3 Ribs under the lip prevent jamming when nested
- 4 Textured bottoms provide a no-slip grip on conveyor belts
- 5 Wide stacking ledge allows totes to securely stack without lids in place
- 6 Lids have tie holes for extra security



## PRODUCT HIGHLIGHTS

- **FUNCTIONAL** – Ideal for shipping, transfer and storage applications
- **STACKBLE** – NSTs stack with or without lids for storage and shipping
- **NESTABLE** – Totes nest when empty
- **DURABLE** – Strong, industrial-grade polymer will not rust, corrode or bend out of shape even when fully loaded
- **COST-EFFECTIVE** – Long service life resulting in lower replacement costs
- **FDA-COMPLIANT** – NSTs are manufactured from FDA-compliant materials
- **VARIETY** – Available in 9 sizes and 3 colors: Red, Blue and Gray. Available in Clear, minimum quantities apply

## COLORS

Red, Blue, Gray



## NON-STANDARD COLOR†

Clear



†Minimum quantities apply.



# Nest & Stack Totes

EXTREMELY DURABLE INDUSTRIAL-GRADE TOTES

800.253.2467  
akro-mils.com

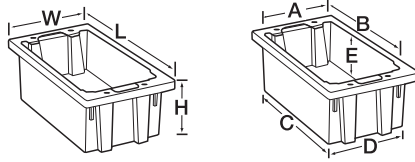

Nest & Stack Totes (NSTs)		Outside Dimensions (In.)			Inside Dimensions (In.)					Capacity/Qty.				Accessories		
Model No.	In Stock Colors Other Colors Require Minimum Qty.	L	W	H	A	B	C	D	E	Cu. Ft.	Gal	Lbs.	Tote Ctn. Qty.	Stacking Height	Lid Model	Lid Ctn. Qty.
35180	Blue, Gray, Red	18	11	6	10	15	14-3/8	9-3/8	5-7/8	0.5	3.7	45	6	6	35181	6
35185	Blue, Gray, Red	18	11	9	10	15	14-1/8	9-1/8	8-7/8	0.76	5.69	60	6	6	35181	6
35190	Blue, Gray, Red	19-1/2	15-1/2	10	14-1/2	15-1/2	14-3/4	13-1/2	9-7/8	1.2	9	65	6	6	35191	6
35195	Blue, Gray, Red	19-1/2	15-1/2	13	14-1/2	15-1/2	14-5/8	13-3/8	12-7/8	1.7	12.93	85	6	6	35191	6
35200	Blue, Gray, Red	19-1/2	13-1/2	8	12-3/8	15-3/4	15-1/4	11-1/2	7-7/8	0.8	6.1	55	6	6	35201	6
35225	Blue, Gray, Red	23-1/2	19-1/2	10	18-1/4	19-3/8	18	16-7/8	9-7/8	2	14.98	70	3	6	35231	3
35230	Blue, Gray, Red	23-1/2	19-1/2	13	18-1/8	19-3/8	18	16-7/8	12-7/8	2.6	19.4	90	3	6	35231	3
35240	Blue, Gray, Red	23-1/2	15-1/2	12	14-1/4	19-3/8	18-1/4	13	11-7/8	1.7	12.9	75	3	6	35241	3
35300	Blue, Gray, Red	29-1/2	19-1/2	15	18-1/4	25	23-1/2	16-5/8	14-7/8	3.7	27.4	100	3	6	35301	3

One color per carton. Specify color: Red, Blue or Grey. Order in carton quantities.

Label Holders		
Model No.	Label Size (In.)	Pkg. Qty.
35010	5 x 3-3/4	6

## ACCESSORIES



**Lids**  
Protect contents from dust and damage, include tie holes



**Clear Plastic Label Holders**  
Accommodate labels up to 5" x 3 3/4"





# Akro-Grid

## DIVIDABLE GRID CONTAINERS

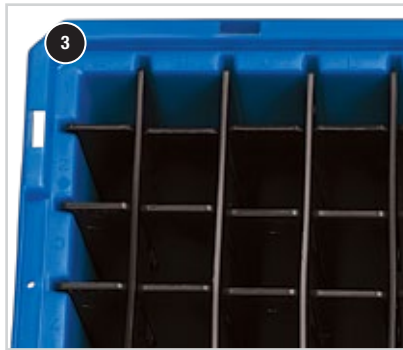
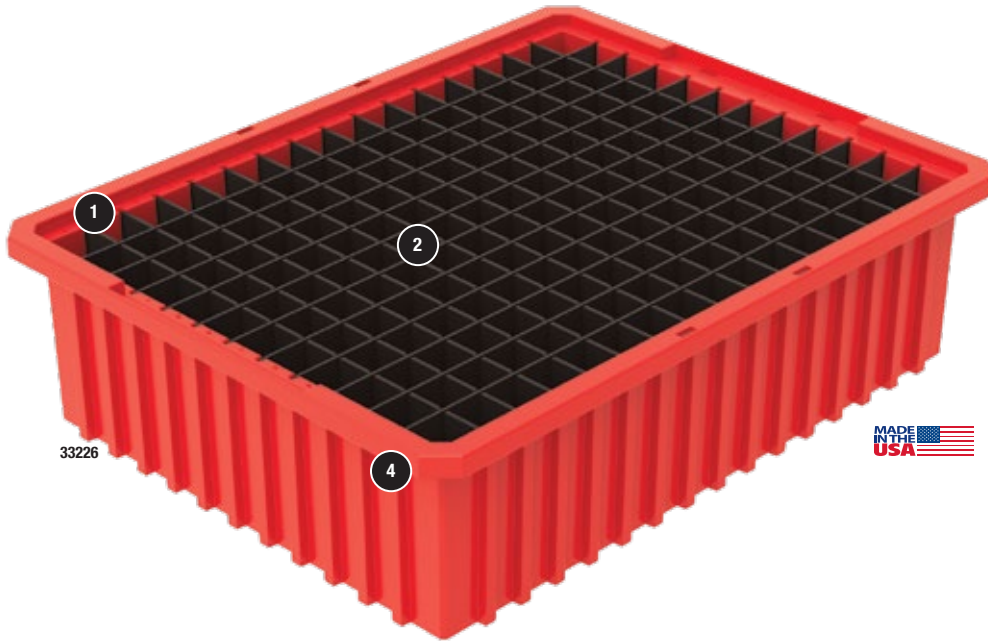

### FEATURES

- 1 Divider slots allow you to create hundreds of compartment sizes
- 2 Dividers (sold separately) allow subdivision of the containers to a 1/8" square compartment size
- 3 Molded-in letter/number system for easy parts tracking
- 4 Strong stacking rims and external ribbing provide added strength

### PRODUCT HIGHLIGHTS

- **FUNCTIONAL** – Compatible with most racks, shelving and automated storage retrieval systems
- **DURABLE** – Injection-molded from industrial-grade polymers. Resists most solvents and chemicals
- **COST-EFFECTIVE** – Longer service life resulting in lower replacement costs
- **VARIETY** – Available in 12 sizes and 3 colors: Red, Blue and Gray. Available in Clear, minimum quantities apply

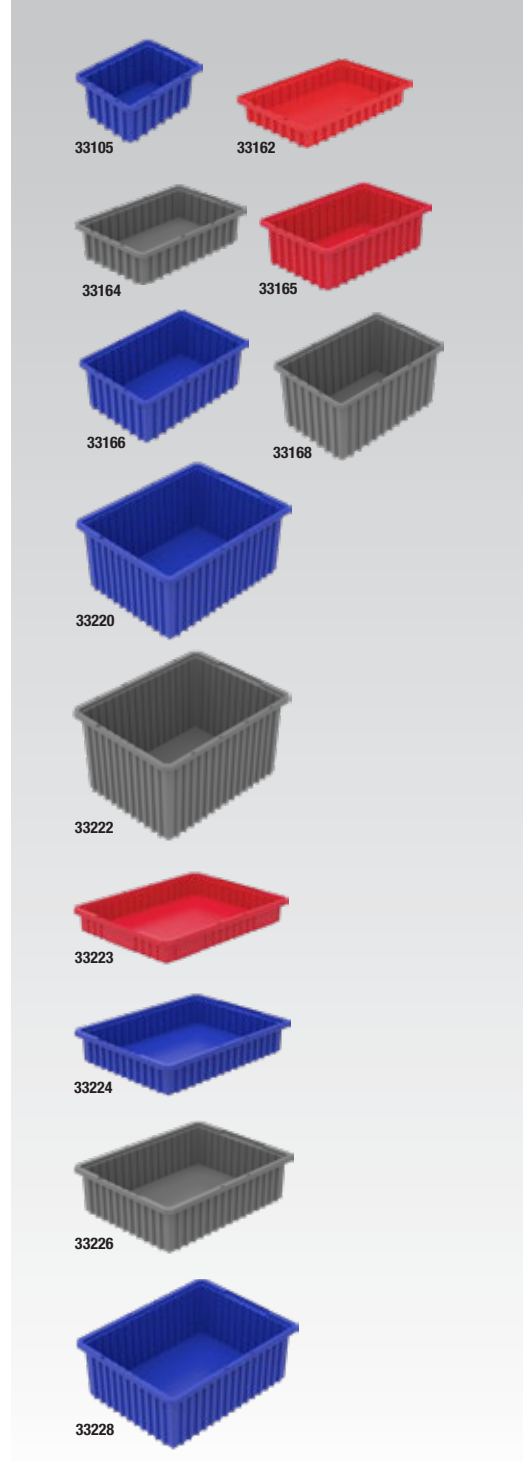

### STANDARD COLORS

Red, Blue, Gray



### NON-STANDARD COLOR†

Clear



†Minimum quantities apply.

# Akro-Grid

## DIVIDABLE GRID CONTAINERS

800.253.2467  
akro-mils.com

HEAVY-DUTY TOTES  
& CONTAINERS

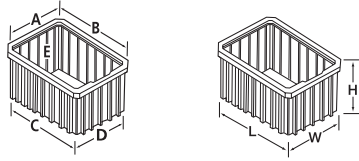

Akro-Grids	In Stock Colors Other Colors Require Minimum Qty.	Outside Dimensions (In.)			Inside Dimensions (In.)					Capacity/Qty.				Accessories			
		L	W	H	A	B	C	D	E	Cu. Ft.	Gal	Lbs.	Bin Ctn. Qty.	Long Divider*	Short Divider*	Divider Pkg. Qty.	Max. No. of Compartments
33105	Blue, Gray, Red	10-7/8	8-1/4	5	6-11/16	9-5/16	9-1/8	6-1/2	4-5/8	.16	1.2	25	20	42105 (5)	41105 (7)	6	48
33162	Red	16-1/2	10-7/8	2-1/2	9-3/16	14-13/16	14-3/4	9-1/8	2-3/8	0.20	1.5	20	12	42162 (7)	—	6	96
33164	Blue, Gray, Red	16-1/2	10-7/8	4	9-3/8	14-15/16	14-13/16	9-3/16	3-7/8	.29	2.2	20	12	42164 (7)	41164 (11)	6	96
33165	Red	16-1/2	10-7/8	5	9-3/16	14-13/16	14-5/8	9	4-7/8	0.39	2.9	35	12	42165 (7)	—	6	96
33166	Blue, Gray, Red	16-1/2	10-7/8	6	9-5/16	14-7/8	14-3/4	9-1/8	5-9/16	.44	3.3	35	8	42166 (7)	41166 (11)	6	96
33168	Blue, Gray, Red	16-1/2	10-7/8	8	9-5/16	14-15/16	14-5/8	9-1/16	7-9/16	.59	4.4	40	6	42168 (7)	41168 (11)	6	96
33220	Blue, Gray, Red	22-3/8	17-3/8	10	15-1/4	20-1/8	19-7/8	14-7/8	9-7/8	1.66	12.4	50	2	42220 (11)	41220 (15)	6	192
33222	Blue, Gray, Red	22-1/2	17-1/2	12	15-5/16	20-5/16	19-15/16	14-15/16	11-13/16	2.10	15.9	60	3	42222 (11)	—	6	192
33223	Blue, Gray, Red	22-1/2	17-3/8	3	15-7/16	20-1/2	20-7/16	15-3/8	2-1/2	.47	3.5	30	6	42223 (11)	41223 (15)	6	192
33224	Blue, Gray, Red	22-3/8	17-3/8	4	15-1/16	20-1/16	20	15	3-7/8	.61	4.6	30	6	42224 (11)	41224 (15)	6	192
33226	Blue, Gray, Red	22-3/8	17-3/8	6	15-1/8	20-1/8	19-7/8	14-7/8	5-7/8	.96	7.2	40	4	42226 (11)	41226 (15)	6	192
33228	Blue, Gray, Red	22-3/8	17-3/8	8	15-1/8	20-1/8	19-7/8	14-7/8	7-7/16	1.30	9.7	50	3	42228 (11)	41228 (15)	6	192

Order in carton quantities. One color per carton. Specify Red, Blue or Gray. Also available in Clear, minimum quantities apply. \*() = max # of dividers.

Clear Snap-On Lids	Outside Dimensions (In.)			Fits Grid No.	Ctn. Qty.
Model No.	L	W	H		
33011	11-1/2	8-11/16	15/16	33105	10
33061	17-3/16	11-5/16	15/16	33162, 33164, 33166, 33168	4
33023	23-5/16	18-1/16	15/16	33220, 33222, 33223, 33224, 33226, 33228	3

Label Holders			
Model No.	Label Size (In.)	Fits Grid No.	Pkg. Qty.
35010	5 x 3-3/4	Fits all except 33164, 33223, 33224	6

## ACCESSORIES



**Dividers**  
Allow subdivision  
of the containers  
down to 1 1/8" square  
compartments



**Clear Plastic  
Label Holders**  
Snap securely on any  
side of the container  
(except 33164,  
33223, 33224)



**Clear Snap-  
On Lids**  
Durable injection-  
molded lids keep  
contents clean  
yet visible

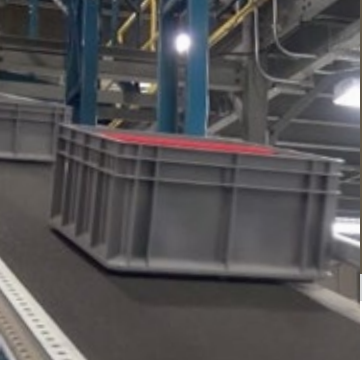

# Multi-Load Tote

DESIGNED FOR MINI-LOAD AUTOMATED STORAGE AND RETRIEVAL SYSTEMS (AS/RS)



## FEATURES

- 1 Reinforced bottom, ribbed side walls and a reinforced rim for added strength and stability
- 2 Straight walls for efficient cubing on pallets and AS/RS systems
- 3 Designated 2" x 4" label areas on length side of tote provide consistent scanning and allow for easy tote orientation at picking stations
- 4 The unique sidewall clip design allows cups to attach quickly and securely to the tote
- 5 Solid reinforced bottom has large flat areas for a smooth and quiet ride on conveyors

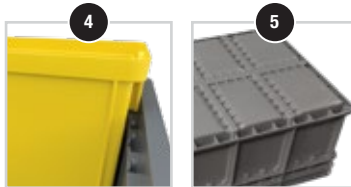

COLOR  
Gray



Dividers cross link to create 4 to 8 sturdy compartments.

## PRODUCT HIGHLIGHTS

- **FUNCTIONAL** – Versatile tote for general storage and logistics applications
- **DURABLE** – Injection-molded from industrial-grade polymers; patented design allows cups to remain stable and secure in the most demanding applications

Multi-Load Totes & Accessories		Outside Dimensions (mm)			Outside Dimensions (In.)			Capacity/Qty.		
Model No.	Description	L	W	H	L	W	H	Cu. Ft.	Lbs.	Ctn. Qty.
38358GRY	Multi-Load Tote - Gray	600	400	220	23-5/8	15-3/4	8-21/32	1.50	80	4
38008YEL*	1/8 Cup - Yellow	184	136	210	7-1/4	5-3/8	8-9/32	0.14	–	12
38004RED*	1/4 Cup - Red	369	136	210	14-17/32	5-3/8	8-9/32	0.29	–	6
48300*	Length Divider - Black	–	–	–	–	–	–	–	–	1
48301*	Width Divider - Black	–	–	–	–	–	–	–	–	3

Order in carton quantities. \*Non-stock, minimum quantities apply.

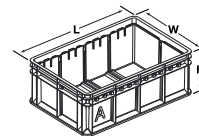

## ACCESSORIES



**Length Dividers**  
Have crosslink tabs that can be removed when used with width dividers



**Width Dividers**  
Have crosslink tabs that can be removed when used with length dividers



**1/4 Bin Cup**  
Create up to 4 secure compartments



**1/8 Bin Cup**  
Create up to 8 secure compartments





# Straight Wall Containers

## INDUSTRIAL REUSABLE CONTAINERS

800.253.2467  
akro-mils.com

HEAVY-DUTY TOTES  
& CONTAINERS

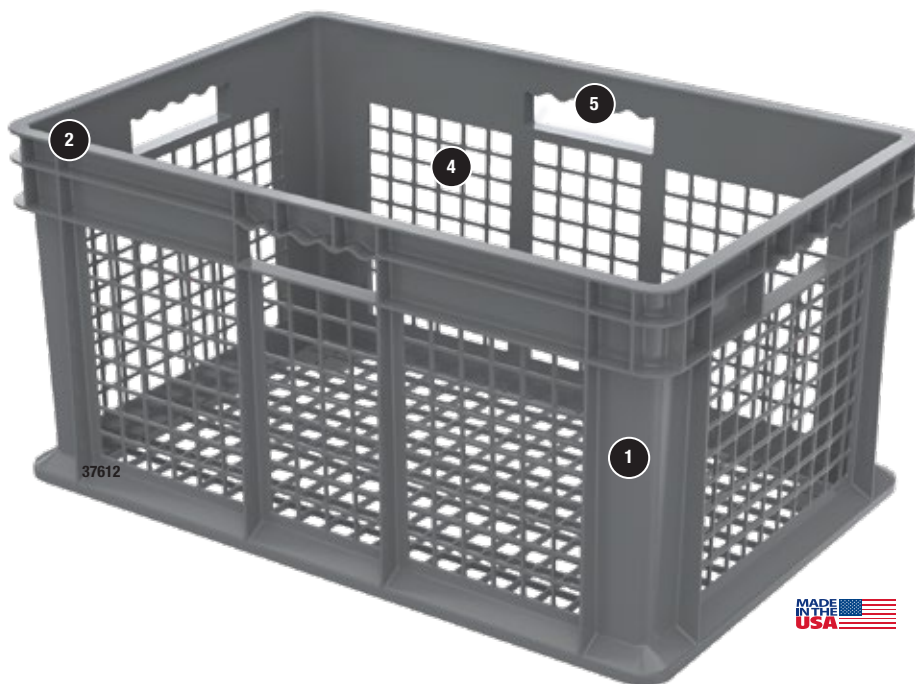

**COLOR**  
Gray



### FEATURES

- 1 1" wall thickness for secure stacking
- 2 Strong 1" wide stacking rims and external ribbing provide added strength
- 3 Straight walls provide efficient cubing in trucks and on pallets
- 4 Open .72 x .90 mesh pattern allows high visibility and good airflow
- 5 Large handles on 4 sides for easy and comfortable grip

### PRODUCT HIGHLIGHTS

- **FUNCTIONAL** – Reusable shipping, storage and work-in-process containers
- **SOLID** – Smooth inner walls for easy, sanitary cleaning
- **MESH** – Allow air ventilation and drainage
- **DURABLE** – Injection-molded from industrial-grade polymers
- **VARIETY** – Available in 12 configurations



Straight Wall Containers (SWCs)			Outside Dimensions (In.)			Inside Dimensions Bottom (In.)			Capacity/Qty.		Stacked Capacity/Qty.		
Model No. Mesh Side & Base	Model No. Mesh Side/Solid Base	Model No. Solid Side & Base	L	W	H	L	W	H	Cu. Ft.	Gal.	Container Ctn. Qty.	Solid Bottom	Mesh Bottom
37208	37278	37288	15-3/4	11-3/4	8-1/4	14	10	8	0.89	5.12	12	83 lbs./6	30 lbs./6
37608	37678	37688	23-3/4	15-3/4	8-1/4	22	14	8	1.78	11.19	4	83 lbs./6	45 lbs./6
37612	37672	37682	23-3/4	15-3/4	12-1/4	22	14	12	2.67	8.32	3	125 lbs./5	45 lbs./5
37616	37676	37686	23-3/4	15-3/4	16-1/8	22	14	16	3.55	11.07	2	150 lbs./4	45 lbs./4

Order in carton quantities.

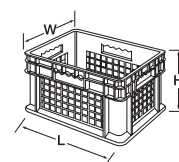



# Rail Hanging Systems

## IDEAL SYSTEMS FOR WORKSTATIONS



UP TO  
500  
LBS.



COLOR  
Gray



### HOW TO CHOOSE: Rails vs. Louvers

**Rails:** Constructed of individual steel rails that span between uprights. Weigh less than louvered panels, more economical, small footprint, easy to remove bins from rails.

**Louvers:** (Page 28) Steel panels with rows of punched louvers. More storage capacity, greater selection of styles. Panels can be attached to the wall, freeing floor space. Rivet racks come with the panels already riveted to the frame.



### FEATURES

- 1 14-gauge steel rails securely support AkroBins®, 19-Series Cabinets and InSight® Ultra-Clear Bins (sold separately)
- 2 Heavy-duty steel for strength and durability
- 3 Durable powder-coated finish

### PRODUCT HIGHLIGHTS

- **EFFICIENT** – Allow for fast, easy organization and parts retrieval
- **SINGLE-SIDED** – Units are ideal for placement against a wall to save space
- **DOUBLE-SIDED** – Units can “float” in any room environment and can be picked from both sides
- **MOBILE KIT** – Available to mobilize two-sided rack
- **STEEL RAIL** – Wall mountable rail is ideal for supply rooms and workstations



# Rail Hanging Systems

## IDEAL SYSTEMS FOR WORKSTATIONS

800.253.2467  
akro-mils.com

Rail Hanging Systems				Dimensions (In.)			AkroBins Model No. ‡													InSight Bins ‡				19-Series Cabinets	
Model No.	Description	Wt. Cap.	Ctn. Qty.	L	W	H	30210	30220	30224	30230	30234	30235	30237	30239	30240	30250	30255	30260	30265	30270	305A1	305A3	305A5	305B1	
30008*	Rack, 1-Sided	250	1	36	14-1/8	53	96	96	64	48	48	24	40	24	24	12	16	12	16	8	96	96	96	48	6
30016*	Rack, 2-Sided	500	1	36	20	53	192	192	128	96	96	48	80	48	48	24	32	24	32	16	192	192	192	96	12
30148	Steel Rail	110	1	47-13/16	5/8	3	11	11	11	8	8	4	8	5	5	2	2	4	5	2	11	11	11	8	2
30812	Bin Cart	250	1	38-1/2	24	36-1/2	96	96	64	48	48	24	40	24	24	12	16	12	16	8	96	96	96	48	12

\*Can be assembled as a 12 or 16 rail rack. ‡Do not exceed rail weight capacity.

Mobile Kit					
Model No.	Description	Wt. Cap.	Ctn. Qty.	Fits Hanging System No.	Casters
30424	Mobile Kit - Casters & Handle	500	1	30016	4" Polyolefin
98400	Suspension Straps (Set of 2) † ‡	-	1	30008, 30016, 30812	-

† ‡ 98400 suspension straps required for hanging 19-Series Cabinets. Two straps per cabinet needed to secure cabinet to rack.

## ACCESSORIES

### Suspension Straps Model No 98400

Hang 19-Series Cabinets  
securely to rail rack, (see  
page 38)



30016 with (1) 30424,  
(12) 98400, (12) 19715



30016240SC

Rail Hanging System Kits			Bin Dimensions (In.)				
Model No.	Description	Bin Model No.	L	W	H	Bin Qty.	Available Colors
30016220SC	DbI-Sided Rack with Clear AkroBins	30220SCLAR	7-3/8	4-1/8	3	192	SC
30016240SC	DbI-Sided Rack with Clear AkroBins	30240SCLAR	14-3/4	8-1/4	7	48	SC

SC=Clear.





# Louvered Hanging Systems : Louvered Rack Dollies

CUSTOMIZABLE VERTICAL STORAGE FOR HANGING BINS

UP TO  
2000  
LBS.

## HOW TO CHOOSE: Louvers vs. Rails

**Louvers:** Steel panels with rows of punched louvers. More storage capacity, greater selection of styles. Panels can be attached to the wall, freeing floor space. Rivet racks come with the panels already riveted to the frame.

**Rails:** (Page 26) Constructed of individual steel rails that span between uprights. Weigh less than louvered panels, more economical, small footprint, easy to remove bins from rails.



30653



## FEATURES

- 1 Louvered Panels securely support AkroBins® and InSight® Bins (sold separately, see Pgs. 4, 6)
- 2 Heavy-duty 16-gauge, cold-rolled steel for strength and durability
- 3 Attractive, durable powder-coated finish
- 4 Save installation time with Rivet Racks! Models 30661, 30638 and 30676 are full louvered panels mounted to a heavy-duty frame



## PRODUCT HIGHLIGHTS

- **EFFICIENT** – Wall-mounted units keep items out of the way, off the floor and off the work table
- **FLOOR RACKS** – Can be placed near work areas to improve productivity
- **SINGLE-SIDED RACKS** – Can be placed against a wall to save floor space
- **DOUBLE-SIDED RACKS** – Expand storage options
- **MOBILE KITS** – Available to mobilize racks; easily relocate supplies without unloading bins



WALL PANELS



30655

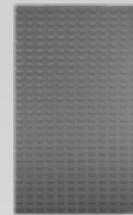

30161

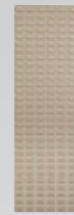

30118

HEAVY-DUTY FLOOR RACKS



30651



30653

RIVET FLOOR RACKS

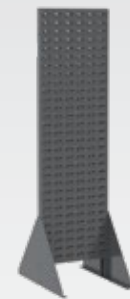

30658



30661



30676

## COLORS

Gray, Beige, Textured White





# Louvered Hanging Systems : Louvered Rack Dollies

CUSTOMIZABLE VERTICAL STORAGE FOR HANGING BINS

800.253.2467  
akro-mils.com

AkroBin Louvered Hanging Systems			Dimensions (In.)				Rack Wt. Cap. (lbs.)	AkroBin Quantity to Fit Louvered Hanging System – AkroBins Model No.													
Model No.	Description	Ctn. Qty.	L	W	H	30210		30220	30224	30230	30234	30235	30237	30239	30240	30250	30255	30260	30265	30270	30320
30618#	Louvered Wall Panel	4	18	5/16	19	160	16	16	12	9	9	3	6	4	4	2	3	1	2	1	-
30632	Single Row Louvered Panel	2	31-15/16	5/16	3	80	7	7	7	5	5	2	5	3	3	1	1	2	3	1	-
30636*#	Louvered Wall Panel	4	35-3/4	5/16	19	160	32	32	24	18	18	9	15	8	8	4	6	3	4	2	3
	2 Louvered Wall Panels		35-3/4	5/16	37	-	72	72	48	36	36	18	30	16	16	8	12	9	12	6	6
	3 Louvered Wall Panels		35-3/4	5/16	55	-	104	104	72	54	54	27	45	24	24	12	18	12	20	8	9
	4 Louvered Wall Panels		35-3/4	5/16	73	-	144	144	96	72	72	36	60	36	36	18	24	18	28	12	12
30655	Louvered Wall Panel	1	52	5/16	34-1/8	750	96	96	60	45	45	20	40	24	24	12	15	8	18	6	5
30161*	Louvered Wall Panel	1	36	5/16	61	1000	120	120	80	60	60	30	50	28	28	14	20	15	24	10	10
30118*#	Louvered Wall Panel	1	18	5/16	61	500	60	60	40	30	30	10	20	14	14	7	10	5	12	5	-
30651	Heavy-Duty Single-Sided Floor Rack	1	35-3/4	17	75-1/8	1000	144	144	96	72	72	36	60	36	36	18	24	18	28	12	12
30653	Heavy-Duty Double-Sided Floor Rack	1	35-3/4	32	75-1/8	2000	288	288	192	144	144	72	120	72	72	36	48	36	56	24	24
30658	Double-Sided Rivet Floor Rack	1	18	25	66-3/8	500	120	120	80	60	60	20	40	28	28	14	20	10	24	10	-
30661	Single-Sided Rivet Floor Rack	1	36-3/16	13-1/2	66-3/8	500	120	120	80	60	60	30	50	28	28	14	20	15	24	10	10
30676	Double-Sided Rivet Floor Rack	1	36-3/16	25	66-3/8	1000	240	240	160	120	120	60	100	56	56	28	40	30	48	20	20
LVDMOBILE	Gray Mobile Kit for 30676	1	-	-	-	1500	-	-	-	-	-	-	-	-	-	-	-	-	-	-	-
30661DOLLYGY	Gray Floor Rack Dolly for 30661	1	37	24	6	500	-	-	-	-	-	-	-	-	-	-	-	-	-	-	-

\*Also available in Beige. #Also available in Textured White. Specify color when ordering. Beige = BEIGE, White = TEXWHT, GY = Gray.

## Louvered Rack Dollies

EASILY MOVE FULLY LOADED RACKS



### RELATED PRODUCTS

Racks and panels can support a variety of bins and cabinets:



4-5  
AkroBins



6  
InSight Bins

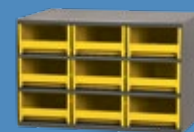

38  
19-Series Cabinets

# Louvered Hanging System Accessories : AkroShelf®

MAXIMIZE YOUR VERTICAL STORAGE SYSTEMS

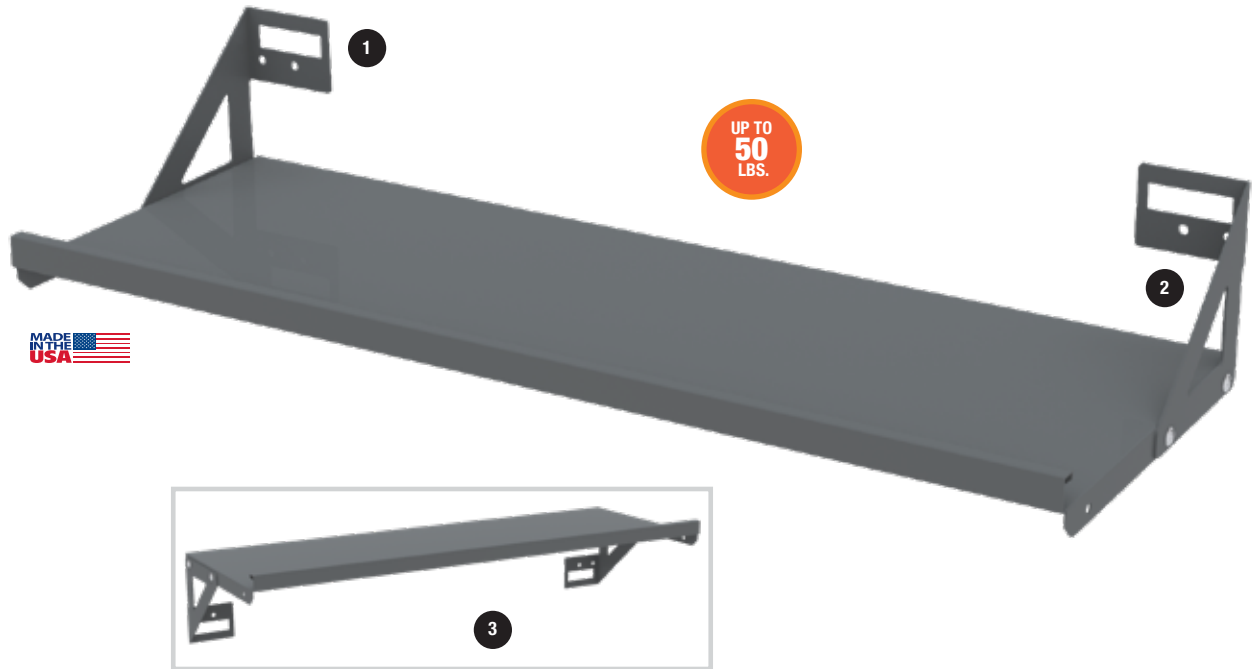

## FEATURES

- 1 Slides down securely onto louvered panels; can be quickly removed
- 2 “Bracket Up” option creates a bottom shelf
- 3 “Bracket Down” option creates a top shelf

AkroShelf		Shelf Dimensions (In.)			Capacity (Lbs.)	Ctn. Qty.
Model No.	Description	W	L	H		
30635GY	AkroShelf	12-3/4	35-5/8	6-7/16	50	4

Caution: Not to be used as a step.

**COLORS**  
Gray



# Louvered Bench Racks

LOUVERED TABLETOP STORAGE FOR HANGING BINS

800.253.2467  
akro-mils.com



## Louvered Bench Rack

KEEP PARTS AND SUPPLIES IN EASY REACH

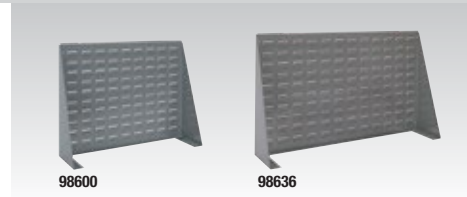

COLOR  
Gray



98600 with 30220



### FEATURES

- 1 Louvered Panels securely support AkroBins® and InSight® Bins (sold separately, see Pgs. 4, 6)
- 2 Heavy-duty 16-gauge, cold-rolled steel for strength and durability
- 3 Attractive, durable powder-coated finish

### ACCESSORIES

**Suspension Straps**  
Model No 98400  
Hang 19-Series Cabinets securely to Bench Rack



Louvered Bench Rack		Dimensions (In.)			Rack Wt. Cap.(lbs.)	AkroBin Quantity to Fit Louvered Hanging System – AkroBins Model No.													
Model No.	Ctn. Qty	L	W	H		30210	30220	30224	30230	30234	30235	30237	30239	30240	30250	30255	30260	30265	30320
98600	1	27-15/16	8-9/16	19-9/16	120	30	30	18	12	12	6	12	6	6	2	3	2	6	–
98636	1	36	8	20	120	40	40	24	18	18	9	15	8	8	4	6	3	8	3

# Pick Racks

HIGH-DENSITY STORAGE WITH ANGLED SHELVES



UP TO  
**1800**  
LBS.

APRD with 30120YELLO Shelf Bins, APRDMOBILE



COLOR  
Gray



APRBENCH



APRS



APRD18



## FEATURES

- 1 16-gauge steel construction
- 2 Angled shelves keep parts at the front of bin
- 3 Works with Akro-Mils' industry-leading Shelf Bins, ShelfMax® Bins, Indicator® Bins, AkroDrawers® and System Bins™
- 4 Durable, powder-coated finish

## PRODUCT HIGHLIGHTS

- **EFFICIENT** – Improve workspace organization and efficiency
- **HEAVY-DUTY** – Up to 1,800 lb. capacity with Double-Sided 18" Racks; Bench Rack 100 lbs. per shelf
- **VARIETY** – Choose from 3 styles: Single-Sided, Double-Sided, Bench, and two shelf depths: 12" and 18"

12" Deep Pick Rack 12" D x 36¾" W x 60¼" H				Shelf Dimensions (in.)		
Model No.	Description	Wt. Capacity (Lbs.)	Caster	D	L	H
APRS	Single-Sided Pick Rack (no bins)	400	–	12-1/8	35-5/8	6-7/16
APRD	Double-Sided Pick Rack (no bins)	800	–	12-1/8	35-5/8	6-7/16
APRDMOBILE	Mobile Kit (Handle & Dolly) for Double-Sided Pick Rack	500	4" x 1½" Polyolefin	–	–	–

Bench Rack 12" D x 36¾" W x 25" H				Bin Dimensions (in.)			
Model No.	Description	Bin Model #	Available Bin Color	L	W	H	Bin Qty.
APRBENCH	Bench Pick Rack, No Bins	–	–	–	–	–	–
APRBENCH120	Bench Rack with Yellow Shelf Bins	30120	Y	11-5/8	4-1/8	4	24
APRBENCH150	Bench Rack with Yellow Shelf Bins	30150	Y	11-5/8	8-3/8	4	12

Y = Yellow

18" Deep Pick Rack 18" D x 36¾" W x 60¼" H				Shelf Dimensions (in.)		
Model No.	Description	Wt. Capacity (Lbs.)	Caster	D	L	H
APRS18	Single-Sided Pick Rack (no bins)	900*	–	18-1/8	35-5/8	6-7/16
APRD18	Double-Sided Pick Rack (no bins)	1800**	–	18-1/8	35-5/8	6-7/16
APRD18MOBILE	Mobile Kit (Handle & Dolly) for Double-Sided Pick Rack	1800	5" x 2" Phenolic	–	–	–

\*When anchored to wall and floor. \*\*When anchored to floor.



# Pick Rack Systems

## HIGH-DENSITY STORAGE WITH ANGLED SHELVES

800.253.2467  
akro-mils.com



APRS150Y



APRD080B

12" Deep Single-Sided Pick Rack			Bin Dimensions (In.)				
Model No.	Description	Bin Model No.	L	W	H	Bin Qty.	Available Colors
APRS110Y	Rack with Yellow Shelf Bins	30110	11-5/8	2-3/4	4	96	Y
APRS150Y	Rack with Yellow Shelf Bins	30150	11-5/8	8-3/8	4	32‡	Y
APRS080B	Rack with Blue ShelfMax	30080	11-5/8	8-3/8	6	32	B

‡Bonus bins included. B=Blue, Y=Yellow.

12" Deep Double-Sided Pick Rack			Bin Dimensions (In.)				
Model No.	Description	Bin Model No.	L	W	H	Bin Qty.	Available Colors
APRD110Y	Rack with Yellow Shelf Bins	30110	11-5/8	2-3/4	4	192	Y
APRD120Y	Rack with Yellow Shelf Bins	30120	11-5/8	4-1/8	4	128‡	Y
APRD080B	Rack with Blue ShelfMax	30080	11-5/8	8-3/8	6	64	B

‡Bonus bins included. B=Blue, Y=Yellow.

### CUSTOM STORAGE SOLUTIONS

Pair Pick Racks with Shelf Bins, page 12; ShelfMax® Bins, page 13; Indicator® Bins, page 14; AkroDrawers®, page 15; or System Bins, page 16.

### HOW MANY BINS FIT ON MY PICK RACK?

12" Single Sided Rack					12" Double Sided Rack					18" Single Sided Rack					18" Double Sided Rack				
Bin Model No.	L	W	H	Bin Qty.	Bin Model No.	L	W	H	Bin Qty.	Bin Model No.	L	W	H	Bin Qty.	Bin Model No.	L	W	H	Bin Qty.
30110	11-5/8	2-3/4	4	96	30110	11-5/8	2-3/4	4	192	30128	17-7/8	4-1/8	4	72‡	30128	17-7/8	4-1/8	4	132‡
30120	11-5/8	4-1/8	4	64‡	30120	11-5/8	4-1/8	4	128‡	30138	17-7/8	6-5/8	4	48‡	30138	17-7/8	6-5/8	4	84‡
30130	11-5/8	6-5/8	4	40‡	30130	11-5/8	6-5/8	4	80‡	30158	17-7/8	8-3/8	4	36‡	30158	17-7/8	8-3/8	4	72‡
30150	11-5/8	8-3/8	4	32‡	30150	11-5/8	8-3/8	4	64‡	30178	17-7/8	11-1/8	4	24	30178	17-7/8	11-1/8	4	48
30170	11-5/8	11-1/8	4	24	30170	11-5/8	11-1/8	4	48	30048	17-7/8	4-1/8	6	64	30048	17-7/8	4-1/8	6	128
30040	11-5/8	4-1/8	6	64	30040	11-5/8	4-1/8	6	128	30088	17-7/8	8-3/8	6	32	30088	17-7/8	8-3/8	6	64
30080	11-5/8	8-3/8	6	32	30080	11-5/8	8-3/8	6	64	30098	17-7/8	6-5/8	6	40	30098	17-7/8	6-5/8	6	80
30090	11-5/8	6-5/8	6	40	30090	11-5/8	6-5/8	6	80	30048 / 30098	See above			32/20	30048 / 30098	See above			64/40
30040 / 30090	See above			32 / 20	30040 / 30090	See above			64 / 40	36448	17-7/8	4-1/8	4	72‡	36448	17-7/8	4-1/8	4	132‡
36442	11-5/8	4-1/4	4	64‡	36442	11-5/8	4-1/4	4	128‡	36468	17-7/8	6-5/8	4	48‡	36468	17-7/8	6-5/8	4	84‡
36462	11-5/8	6-3/4	4	40‡	36462	11-5/8	6-3/4	4	80‡	31148	17-5/8	3-3/4	4-5/8	72	31148	17-5/8	3-3/4	4-5/8	144
31112	11-5/8	11-1/8	4-5/8	24	31112	11-5/8	11-1/8	4-5/8	48	31168	17-5/8	5-9/16	4-5/8	48	31168	17-5/8	5-9/16	4-5/8	96
31142	11-5/8	3-3/4	4-5/8	72	31142	11-5/8	3-3/4	4-5/8	144	31188	17-5/8	8-3/8	4-5/8	32	31188	17-5/8	8-3/8	4-5/8	64
31162	11-5/8	5-9/16	4-5/8	48	31162	11-5/8	5-9/16	4-5/8	96	31118	17-5/8	11-1/8	4-5/8	24	31118	17-5/8	11-1/8	4-5/8	48
31182	11-5/8	8-3/8	4-5/8	32	31182	11-5/8	8-3/8	4-5/8	64	30318	18	33	5	8‡	30318	18	33	5	16‡
31142, 31162, 31182	See Above			18 / 24 / 8	31142, 31162, 31182	See Above			36 / 48 / 16	‡Bonus bins, (bins are sold in carton quantities).					‡Bonus bins, (bins are sold in carton quantities).				
30312	12	33	5	8‡	30312	12	33	5	16‡										

‡Bonus bins, (bins are sold in carton quantities).

‡Bonus bins, (bins are sold in carton quantities).



# Storage Cases : Utility Boxes

CUSTOMIZABLE, LIGHTWEIGHT, PORTABLE BOXES

## Clear Storage Cases

GRIDDED LID KEEPS ITEMS IN PLACE



05905

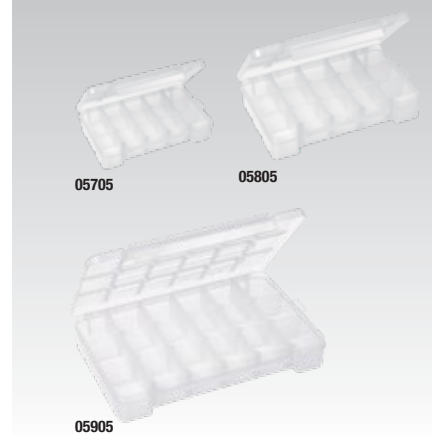

05705

05805

05905

**COLOR**  
Clear



**Small & Medium Cases**

2 Fixed Dividers  
4 Adjustable Dividers

**Large Cases**

2 Fixed Dividers  
5 Adjustable Dividers



### FEATURES

- 1 Grid design in lid keeps items from spilling into other compartments
- 2 Dividers are adjustable for customized storage

### PRODUCT HIGHLIGHTS

- **FUNCTIONAL** – Plastic storage cases are ideal in any setting for parts storage
- **ADJUSTABLE** – Cases include front-to-back adjustable dividers
- **DURABLE** – Molded of clear industrial-grade polymers

Storage Cases		Dimensions (In.)			Capacity/Qty.	
Model No.	Description	L	W	H	Maximum Compartments	Ctn. Qty.
05705	Small Case – 2 Fixed Dividers; 4 Adjustable Dividers	8-5/8	5-1/8	1-5/8	15	12
05805	Medium Case – 2 Fixed Dividers; 4 Adjustable Dividers	11	7	2-3/8	15	6
05905	Large Case – 2 Fixed Dividers; 5 Adjustable Dividers	14-3/8	9-1/2	2-1/2	18	6

Order in carton quantities.

## Utility Boxes

- **VERSATILE** – Perfect for kits
- **ADJUSTABLE** – Includes 2 adjustable dividers
- **FLAT LID** – For easy labeling of case contents

**COLOR**  
Clear



Utility Boxes		Dimensions (In.)			Capacity/Qty.	
Model No.	Description	L	W	H	Maximum Compartments	Ctn. Qty.
96352A	Medium Utility Box – 5 Fixed Dividers	8-5/16	4-5/8	1-1/2	18	12
96352B	Large Utility Box – 4 Fixed Dividers	11	6-3/8	2-1/2	15	6

Order in carton quantities.



96352B

96352A



# Tote Caddy : ProBox™ Toolboxes : Portable Organizers

SMALL PARTS STORAGE

800.253.2467  
akro-mils.com

## Tote Caddy



- **COMPACT** – Hand-held tool and supply caddy
- **FUNCTIONAL** – Deep compartments hold loose parts, cleaning supplies or tools for easy transport; two shallow compartments are perfect for hardware, keys or loose items
- **DURABLE** – Molded of heavy-duty, industrial-grade polymers with a textured finish for lasting durability

**COLORS**  
Blue



Tote Caddy		Dimensions (In.)			Ctn. Qty.
Model No.	Description	L	W	H	
09185BLUE	Tote Caddy - Blue	13-7/8	18-3/8	9	6

Order in carton quantities.



## ProBox™ Toolboxes



- **FUNCTIONAL** – 14" unit includes removable tool tray and metal latch\*
- **SECURE** – 14" unit features oversized padlock eye

**COLOR**  
Red



ProBox Toolbox		Dimensions (In.)			Ctn. Qty.
Model No.	Description	L	W	H	
09912*	12" ProBox	12	6	4	12
09514	14" ProBox	14	8-1/8	8-1/8	6

Order in carton quantities. \*12" unit does not include tray.



09514



09912

## Portable Organizers



- **FUNCTIONAL** – Unique design keeps parts from migrating to other compartments when the lid is shut
- **DIVIDABLE** – Adjustable dividers included for customized storage in both levels

**COLOR**  
Blue/Clear



Portable Organizers		Dimensions (In.)			Capacity/Qty.	
Model No.	Description	L	W	H	Maximum Compartments	Ctn. Qty.
06118	Lid Storage Organizer	18-1/4	13-1/2	3-3/4	12 to 62	1

Order in carton quantities.





# TiltView®

TILTING BINS OFFER VISIBLE, DUST-FREE STORAGE



06705



5



06702



06703



06704



06705



06706

**COLOR**  
Stone



## FEATURES

- 1 Cabinets made of high-impact polystyrene
- 2 Bins made of polystyrene (GPS)
- 3 Molded-in label holder (card stock labels included)
- 4 Neutral Stone color is ideal for any environment
- 5 06702 can slide apart to form two separate bins

## PRODUCT HIGHLIGHTS

- **EFFICIENT** – Space-saving system will improve organization and efficiency in a variety of settings, including medical and pharmacy!
- **FUNCTIONAL** – Can be used on a desktop, and are wall mountable
- **VARIETY** – Available in 5 sizes







06704



TiltView Bins		Dimensions (In.)			Capacity/Qty.	
Model No.	Description	L	W	H	Ctn. Qty.	Capacity Lbs.
06702	2-Bin TiltView	12-5/16	23-5/8	14	1	30
06703	3-Bin TiltView	7-7/8	23-5/8	9-7/16	1	30
06704	4-Bin TiltView	6-3/4	23-5/8	8-3/16	1	25
06705	5-Bin TiltView	5-3/8	23-5/8	6-1/2	1	20
06706	6-Bin TiltView	3-3/4	23-5/8	4-1/2	1	15

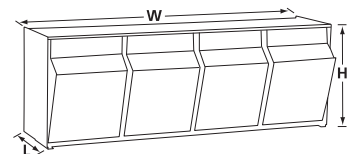



# Steel Storage Cabinets

19-SERIES



## FEATURES

- 1 Chip-proof, durable powder-coated finish
- 2 Heavy-duty 24-gauge, welded-steel frame for strength
- 3 Built-in nesting feet for safe, stable stacking
- 4 Label holder and transparent window for content identification
- 5 Industrial-grade plastic drawers available in 3 colors
- 6 Dovetail dividers lock securely in place and provide up to 8 compartments

## PRODUCT HIGHLIGHTS

- **FUNCTIONAL** – The perfect choice for easy access and organization of small parts. Cabinet size: 17" wide x 11" deep x 11" high. Drawer depth: 10<sup>9</sup>/<sub>16</sub>"
- **SAFE** – No sharp edges to damage parts. Unique rear stop tab on each drawer prevents spills
- **EXPANDABLE** – Cabinets can be used with Rail Racks, ProCart™, Storage-Go-Round, or Louvered Panels with optional Suspension Straps
- **WALL-MOUNTABLE** – 4 "keyhole slots" on back for easy wall mounting
- **VARIETY** – Available in 5 models and 3 drawer colors: Blue, Gray and Black.



19228



19320



19416



19715



19909

## DRAWER COLORS

Blue, Gray, Black



## CABINET COLOR

Gray



## ACCESSORIES



**Suspension Straps**  
Allows 19-Series Cabinets to hang on louvered panels or rail racks

19-Series Heavy-Duty Steel Cabinets			Drawer Dimensions (In.)			Accessories			
Model No.	Description	Drawers Per Cabinet†	W	H	D	Ctn. Qty.	Drawer Model No.	Dividers Model No.	Dividers Pkg. Qty.
19228	Steel Storage Cabinet	28	2-3/16	2-1/16	10-9/16	1	20228	40228*	24
19320	Steel Storage Cabinet	20	3-3/16	2-1/16	10-9/16	1	20320	40320*	30
19416	Steel Storage Cabinet	16	4	2-1/8	10-9/16	1	20416	40416*	33
19715	Steel Storage Cabinet	15	3-3/16	3-1/16	10-9/16	1	20715	40715*	30
19909	Steel Storage Cabinet	9	5-3/16	3-1/16	10-9/16	1	20909	40909*	27
98400	Suspension Straps (Set of 2)	–	–	–	–	12 sets	–	–	–

One drawer color per cabinet. Specify Blue, Gray or Black when ordering. †One label per drawer included. \*Non stock item, minimum quantities apply.

# Storage-Go-Round : Mobile Steel Cabinet Rack

HIGH-DENSITY STORAGE OPTIONS

800.253.2467  
akro-mils.com



## Storage-Go-Round

1,000 LBS. OF PARTS IN 1 SQUARE YARD



### FEATURES

- 1 Securely holds (20) 19-Series cabinets, sold separately
- 2 Small workspace footprint: compact swing diameter 43<sup>5</sup>/<sub>8</sub>"
- 3 Ball-transfer base rotates for easy access to parts
- 4 Durable, powder-coated finish
- 5 Mix or match color options and drawer sizes to take organization to the next level!

### PRODUCT HIGHLIGHTS

- **CAPACITY** – Holds 20 steel cabinets; weight capacity of 1,000 lbs.
- **EFFICIENT** – Streamlines workflow and order picking
- **DUST-FREE** – Cabinets and drawers minimize dust collection
- **VARIETY** – Mix or match steel cabinet drawer colors: Blue, Gray or Black

COLOR  
Gray



Storage-Go-Round		Assembled Dimensions (In.)		
Model No.	Description	L	W	H
98325	Storage-Go-Round with turntable base*	31	31	60

Assembly required. \*19-Series Cabinets sold separately.

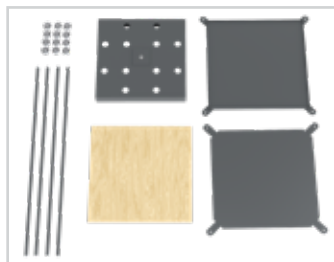

Model No 98325  
19-Series Cabinets sold separately. (See page 38)



UP TO  
1000  
LBS.



## Mobile Steel Cabinet Rack

500 LBS. OF PARTS WITHIN REACH



- **VERSATILE** – Double-sided, mobile rail rack holds up to 12 cabinets, with as many as 336 drawers
- **HEAVY-DUTY** – Supports up to 500 lbs.

COLOR  
Gray



Mobile Steel Cabinet Rack		
Model No.	Description	Required Components Qty.
30016	Double-Sided Rail Rack – 36" W x 24" D x 57" H	1 each
30424	Mobile Kit	1 each
98400	Suspension Straps (Set of 2) † ‡	12 sets

Assembly required. See chart above. † ‡ 98400 suspension straps required for hanging. Two straps per cabinet needed to secure cabinets to rack. Mix/match any 12 Steel Storage Cabinets.

### ACCESSORIES

**Suspension Straps**  
Model No 98400  
Hang 19-Series Cabinets securely to rail rack



UP TO  
500  
LBS.





# Plastic Storage Cabinets

ORGANIZE & PROTECT HARDWARE & OFFICE SMALL PARTS



10124

MADE IN THE USA



## FEATURES

- 1 Cabinets made of rugged, high-impact plastic
- 2 Clear industrial-grade plastic drawers are unbreakable
- 3 Interlocking cabinet frame and face ensure strength and durability
- 4 Drawer dividers are molded into the back of the cabinet



## COLOR

Black, Red



10116



10124



10126



10144



10164

NEW!



10144REDBLK



800.253.2467  
akro-mils.com

Plastic Storage Cabinets are perfect for sorting and displaying large quantities of hardware and other small parts.



**Large Drawer:**  
Outside Dimensions: 6" x 4½" x 2¾"  
Inside Dimensions: 4¾" x 4¼" x 2"

**Small Drawer:**  
Outside Dimensions: 6" x 2¼" x 1½"  
Inside Dimensions: 5¼" x 1¾" x 1½"

Plastic Storage Cabinets			Drawer Qty.		Dimensions (In.)			Ctn. Qty.
Model No.	Description	Available Colors	Large	Small	L	W	H	
10116	16-Drawer Cabinet	BLK	0	16	10-1/2	6-3/8	8-1/2	1
10124	24-Drawer Cabinet	BLK	24	0	20	6-3/8	15-13/16	1
10126	26-Drawer Cabinet	BLK	6	20	20	6-3/8	10-1/4	1
10144	44-Drawer Cabinet	BLK, RED	12	32	20	6-3/8	15-13/16	1
10164	64-Drawer Cabinet	BLK	0	64	20	6-3/8	15-13/16	1

16-Drawer Cabinet has 8 dividers. All other cabinets have 8 small and 4 large dividers.

Additional Dividers (Plastic Cabinets)	
Model No.	Description
40716	16-Pack additional dividers for small drawers
40717	6-Pack additional dividers for large drawers

# Standard Bin Cabinets

ALL-WELDED SOLID DOOR BIN STORAGE CABINETS



UP TO  
**1500**  
LBS.



**AkroBin® Cabinet**  
Model No. AC3624Y  
Louvered panels on back wall and doors. 138 bins.  
Weight capacity 1,200 lbs.



**AkroBin Cabinet with 3 Shelves**  
Model No. AC3624Y3AS  
Louvered panels and 3 full 24" shelves. 102 bins.  
Weight capacity 1,500 lbs.



**AkroBin Cabinet with Flush Doors**  
Model No. AC3618Y  
Louvered panel on back wall. 42 bins.  
Weight capacity 1,000 lbs.



**Bin Cabinet Dolly**  
Model No. AC803624M26  
Convert Standard Cabinets to mobile units!

**COLOR**  
Gray, Putty



**MADE IN THE USA**



## FEATURES

- 1 All-welded cabinets made of 16-gauge steel
- 2 Adjustable shelves hold up to 300 lbs. each
- 3 Louvered back wall panel
- 4 Keyed handle with 3-point locking system. 2 keys included. Replacement keys available, see chart



# Standard Bin Cabinets

ALL-WELDED SOLID DOOR BIN STORAGE CABINETS

800.253.2467  
akro-mils.com

AkroBin Cabinet 36" W x 24" D x 78" H		AkroBin Quantity				
Model No.	Description	30210	30220	30230	30240	30250
AC3624	Gray Cabinet w/ Louvered Panels on Back & Doors, no Bins	-	-	-	-	-
AC3624Y	Gray Cabinet w/ Louvered Panels on Back & Doors with Assorted Yellow AkroBins	48	48	24	12	6

AkroBin Cabinet with Shelves 36" W x 24" D x 78" H		AkroBin Quantity				
Model No.	Description	30210	30220	30230	30240	30250
AC36243AS	Gray Cabinet w/ 3 Shelves, Louvered Panels on Back & Doors, no Bins	-	-	-	-	-
AC3624Y3AS	Gray Cabinet w/ 3 Shelves, Louvered Panels on Back & Doors, with Assorted Yellow AkroBins	48	48	-	-	6

AkroBin Cabinet Flush Door 36" W x 18" D x 78" H		AkroBin Quantity		
Model No.	Description	30230	30240	30250
AC3618	Gray Cabinet w/ Louvered Panels on Back Wall, no Bins	-	-	-
AC3618PUT	Putty Cabinet w/ Louvered Panels on Back Wall, no Bins	-	-	-
AC3618Y	Gray Cabinet w/ Louvered Panels on Back Wall, with Assorted AkroBins	24	12	6
AC3618YPUT	Putty Cabinet w/ Louvered Panels on Back Wall, with Assorted AkroBins	24	12	6

Bin Cabinet Dollies		Dimensions (In.)				
Model No.	Description	L	W	H	Polyolefin Casters	Weight Capacity
AC803618M26	18 x 36 Gray Bin Cabinet Dolly	36-1/2	18-1/2	5-1/4	3 x 1-1/4"	1000 lbs.
AC803624M26	24 x 36 Gray Bin Cabinet Dolly	36-1/2	24-1/2	6-1/2	4 x 1-1/4"	1000 lbs.

Standard Bin Cabinet Replacement Parts	
Model No.	Description
ACKEYF	Keys for AC Cabinets built after 9/2013. Stamped FH333.
ACKEY	Keys for Mini-Cabinet and the Ready-to-Assemble Cabinet; and for AC cabinets prior to 9/2013. Stamped 1333.
AC3618SHELF4PKPUT	4-pack Putty 18" shelf
AC3624SHELF3PK	3-pack Gray 24" shelf



UP TO  
**1200**  
LBS.

AC3624



UP TO  
**1000**  
LBS.

AC3618YPUT

AkroBin Model No.	L	W	H
30210	5-3/8	4-1/8	3
30220	7-3/8	4-1/8	3
30230	10-7/8	5-1/2	5
30240	14-3/4	8-1/4	7
30250	14-3/4	16-1/2	7



Quantities for Standard Cabinets		AkroBin Quantity to Fit Standard Cabinets - AkroBins Model No.														
Model No.	Description	30210	30220	30224	30230	30234	30235	30237	30239	30240	30250	30255	30260	30265	30270	30320
AC3624	Back Wall	144	144	96	72	72	36	60	36	36	18	24	18	28	12	12
	Doors	102	102	0	0	0	0	0	0	0	0	0	0	0	0	0
	Cabinet with Louvered Doors: Total	246	246	96	72	72	36	60	36	36	18	24	18	18	12	12



# Standard Bin Cabinets - Quick-View

ALL-WELDED BIN CABINETS WITH SECURE, VIEWABLE STORAGE



UP TO  
**1000**  
LBS.

AC3618QV

2

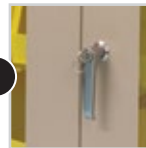

Quick-View Security  
Bin Cabinet  
Model No. AC3618QV240

Lexan™ door panels; louvered back wall panel. Complete with 36 AkroBins. Comes standard in beige. Weight capacity 1,000 lbs.



Quick-View Security  
Bin Cabinet  
Model No. AC3618QV250

Lexan™ door panels; louvered back wall panel. Complete with 18 AkroBins. Comes standard in beige. Weight capacity 1,000 lbs.



Bin Cabinet Dolly  
Model No. AC803618M26  
Convert large cabinets to mobile units!

**COLORS**  
Gray, Beige



**MADE IN THE USA**



## FEATURES

- 1 Durable, lightweight Lexan™ door panels keep out dust and debris (Quick-View)
- 2 Keyed handle with 3-point locking system. 2 keys included. Replacement keys available, see chart on page 43

### Quick-View Security Bin Cabinet 36" W x 18" D x 78" H

Model No.	Description	Bin Model No.	Qty. of Bins
AC3618QV	Beige Cabinet w/ Quick View Doors, Louvered Back, no Bins	—	—
AC3618QVGRY	Gray Cabinet w/ Quick View Doors, Louvered Back, no Bins	—	—
AC3618QV240	Beige Cabinet w/ Quick View Doors, Louvered Back, with AkroBins	30240YELLO	36
AC3618QV250	Beige Cabinet w/ Quick View Doors, Louvered Back, with AkroBins	30250YELLO	18
AC3618QV250S5	Beige Cabinet w/ Quick View Doors, Louvered Back, with AkroBins, 3 Shelves	30250YELLO	18

AkroBin Model No.	L	W	H
30240	14-3/4	8-1/4	7
30250	14-3/4	16-1/2	7

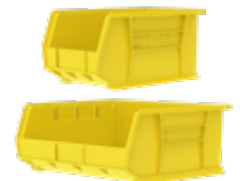

### Quantities for Standard Cabinets

### AkroBin Quantity to Fit Standard Cabinets - AkroBins Model No.

Model No.	Description	30210	30220	30224	30230	30234	30235	30237	30239	30240	30250	30255	30260	30265	30270	30320
AC3618	Cabinet with Flush Doors	144	144	96	72	72	36	60	36	36	18	24	18	28	12	12



# Wire Shelving Components

## BUILD CUSTOM SHELVING UNITS

800.253.2467  
akro-mils.com



### Construction:

- Frame Wire = 6.0mm
- Deck Wire = 3.3mm
- Truss Wire = 4.5mm



COLOR  
Chrome



## FEATURES

- 1 Open wire design minimizes dust accumulation and improves visibility
- 2 Constructed from steel with a chrome finish
- 3 NSF-certified
- 4 Quick-Adjust Clips lock onto shelf posts, and unlock to adjust shelves
- 5 Leveling bolts screw securely into uprights to level shelf system on uneven surfaces

## PRODUCT HIGHLIGHTS

- **EFFICIENT** – Streamlines workflow and order picking
- **FUNCTIONAL** – Works with a variety of Akro-Mils storage products to organize parts and increase efficiency
- **CAPACITY** – Stationary units hold a maximum of 2,000 lbs.; mobile units with 4" casters have a capacity of 400 lbs.; 5" casters have a capacity of 500 lbs. Maximum weight capacity per shelf: 48" or shorter = 800 lbs.; longer than 48" = 600 lbs.
- **ASSEMBLY** – Easy, one-person set-up and installation. No tools required!
- **VARIETY** – Accessories such as liner mats, casters and label holders extend the versatility of the shelves. Multiple shelf sizes available, see chart.

## Wire Shelving System Components

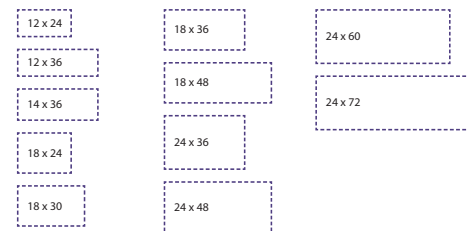

### Horizontal Shelf

#### Wire Shelves - Chrome

Model No.	Description	Ctn. Qty.
AWS1224SHELF	12" x 24" Horizontal Wire Shelf	4
AWS1236SHELF	12" x 36" Horizontal Wire Shelf	4
AWS1436SHELF	14" x 36" Horizontal Wire Shelf	4
AWS1824SHELF	18" x 24" Horizontal Wire Shelf	4
AWS1830SHELF	18" x 30" Horizontal Wire Shelf	4
AWS1836SHELF	18" x 36" Horizontal Wire Shelf	4
AWS1848SHELF	18" x 48" Horizontal Wire Shelf	4
AWS2436SHELF	24" x 36" Horizontal Wire Shelf	4
AWS2448SHELF	24" x 48" Horizontal Wire Shelf	4
AWS2460SHELF	24" x 60" Horizontal Wire Shelf	2
AWS2472SHELF	24" x 72" Horizontal Wire Shelf	2



Shelf Posts



Posts include  
Leveling Foot

#### Wire Shelving Posts - Chrome

Model No.	Description	Ctn. Qty.
AWP54UPRIGHT	54" Shelf Post	4
AWP63UPRIGHT	63" Shelf Post	4
AWP74UPRIGHT	74" Shelf Post	4
AWP86UPRIGHT	86" Shelf Post	4

# Wire Shelving Components

BUILD CUSTOM SHELVING UNITS



4" Swivel Caster



4" Swivel Caster w/Brake



5" Swivel Caster w/Brake

### Caster Sets

Model No.	Description	Pkg. Qty.
AWPCAST4	Set of 4 Casters - 2 w/Brakes 100 x 25 (4")	1
AWPCAST5Y	Set of 4 Casters - 4 w/Brakes 125 x 25 (5")	1

Akro-Mils does not recommend the usage of casters on shelving units taller than 63".



Leveling Feet



Steel Feet Immobilizers



"S" Hooks



Quick-Adjust Clips



Donut Bumper



Angle•Vu™ Label Holder



Angle-Vu	Dimensions (In.)		Cards Per Sheet		Sheets Per Pack		Total No.	
	Model No.	W	H	Cards Per Sheet	Sheets Per Pack	Cards Per Pack	Label Holders	
29306	3	1-1/4	16	3	48	25		

For additional information, see page 14.

### Wire Shelving Accessories

Model No.	Description	Pkg. Qty.
AWFOOTLEVEL4PK	Set of 4 Leveling Steel Feet	4
AWFOOTPLATE4PK	Set of 4 Steel Feet Immobilizers	4
AWDONUT	Donut Bumper	1
AWSHOOK8PK	Set of 8 "S" Hooks	8
AWCLIP4PK	Set of 4 Quick-Adjust Clips	4



Flat Label Holder



Flat Label Holder	Dimensions (In.)		Cards Per Sheet		Sheets Per Pack		Total No.	
	Model No.	W	H	Cards Per Sheet	Sheets Per Pack	Cards Per Pack	Label Holders	
29308	3	1/4	16	3	48	25		

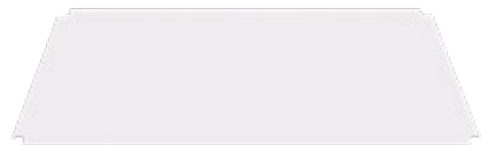

Shelf Liner Mat

### Wire Shelving Shelf Liner Mats

Model No.	Description	Ctn. Qty.
AW1236LINER	12" x 36" Shelf Liner	4
AW1836LINER	18" x 36" Shelf Liner	4
AW1848LINER	18" x 48" Shelf Liner	4
AW2460LINER	24" x 60" Shelf Liner	4
AW2472LINER	24" x 72" Shelf Liner	4

# Wire Shelving Starter Units

## COMPLETE SHELVING UNITS

800.253.2467  
akro-mils.com

Wire Shelving 4-Shelf Starter Units come with 4 shelves, 4 posts and 8 S-Hooks for extending shelving end-to-end, back-to-back or 90 degrees. Posts include leveling feet. Make a mobile unit by adding AWPCAST4 or AWPCAST5Y.



14 x 36 x 54



24 x 48 x 63



18 x 48 x 74



12 x 48 x 86

Wire Shelving Starter Units		Components		
Model No.	Description	Post Qty.	Shelf Qty.	S-Hook Qty.
AWS541224SU	Wire Shelving 54" High 12 x 24 Starter Unit	4	4	1 - 8 Pack
AWS541236SU	Wire Shelving 54" High 12 x 36 Starter Unit	4	4	1 - 8 Pack
AWS541436SU	Wire Shelving 54" High 14 x 36 Starter Unit	4	4	1 - 8 Pack
AWS541824SU	Wire Shelving 54" High 18 x 24 Starter Unit	4	4	1 - 8 Pack
AWS541830SU	Wire Shelving 54" High 18 x 30 Starter Unit	4	4	1 - 8 Pack
AWS541836SU	Wire Shelving 54" High 18 x 36 Starter Unit	4	4	1 - 8 Pack
AWS541848SU	Wire Shelving 54" High 18 x 48 Starter Unit	4	4	1 - 8 Pack
AWS542436SU	Wire Shelving 54" High 24 x 36 Starter Unit	4	4	1 - 8 Pack
AWS542448SU	Wire Shelving 54" High 24 x 48 Starter Unit	4	4	1 - 8 Pack
AWS542460SU	Wire Shelving 54" High 24 x 60 Starter Unit	4	4	1 - 8 Pack
AWS542472SU	Wire Shelving 54" High 24 x 72 Starter Unit	4	4	1 - 8 Pack
AWS631224SU	Wire Shelving 63" High 12 x 24 Starter Unit	4	4	1 - 8 Pack
AWS631236SU	Wire Shelving 63" High 12 x 36 Starter Unit	4	4	1 - 8 Pack
AWS631436SU	Wire Shelving 63" High 14 x 36 Starter Unit	4	4	1 - 8 Pack
AWS631824SU	Wire Shelving 63" High 18 x 24 Starter Unit	4	4	1 - 8 Pack
AWS631830SU	Wire Shelving 63" High 18 x 30 Starter Unit	4	4	1 - 8 Pack
AWS631836SU	Wire Shelving 63" High 18 x 36 Starter Unit	4	4	1 - 8 Pack
AWS631848SU	Wire Shelving 63" High 18 x 48 Starter Unit	4	4	1 - 8 Pack
AWS632436SU	Wire Shelving 63" High 24 x 36 Starter Unit	4	4	1 - 8 Pack
AWS632448SU	Wire Shelving 63" High 24 x 48 Starter Unit	4	4	1 - 8 Pack
AWS632460SU	Wire Shelving 63" High 24 x 60 Starter Unit	4	4	1 - 8 Pack
AWS632472SU	Wire Shelving 63" High 24 x 72 Starter Unit	4	4	1 - 8 Pack

Wire Shelving Starter Units		Components		
Model No.	Description	Post Qty.	Shelf Qty.	S-Hook Qty.
AWS741224SU	Wire Shelving 74" High 12 x 24 Starter Unit	4	4	1 - 8 Pack
AWS741236SU	Wire Shelving 74" High 12 x 36 Starter Unit	4	4	1 - 8 Pack
AWS741436SU	Wire Shelving 74" High 14 x 36 Starter Unit	4	4	1 - 8 Pack
AWS741824SU	Wire Shelving 74" High 18 x 24 Starter Unit	4	4	1 - 8 Pack
AWS741830SU	Wire Shelving 74" High 18 x 30 Starter Unit	4	4	1 - 8 Pack
AWS741836SU	Wire Shelving 74" High 18 x 36 Starter Unit	4	4	1 - 8 Pack
AWS741848SU	Wire Shelving 74" High 18 x 48 Starter Unit	4	4	1 - 8 Pack
AWS742436SU	Wire Shelving 74" High 24 x 36 Starter Unit	4	4	1 - 8 Pack
AWS742448SU	Wire Shelving 74" High 24 x 48 Starter Unit	4	4	1 - 8 Pack
AWS742460SU	Wire Shelving 74" High 24 x 60 Starter Unit	4	4	1 - 8 Pack
AWS742472SU	Wire Shelving 74" High 24 x 72 Starter Unit	4	4	1 - 8 Pack
AWS861224SU	Wire Shelving 86" High 12 x 24 Starter Unit	4	4	1 - 8 Pack
AWS861236SU	Wire Shelving 86" High 12 x 36 Starter Unit	4	4	1 - 8 Pack
AWS861436SU	Wire Shelving 86" High 14 x 36 Starter Unit	4	4	1 - 8 Pack
AWS861824SU	Wire Shelving 86" High 18 x 24 Starter Unit	4	4	1 - 8 Pack
AWS861830SU	Wire Shelving 86" High 18 x 30 Starter Unit	4	4	1 - 8 Pack
AWS861836SU	Wire Shelving 86" High 18 x 36 Starter Unit	4	4	1 - 8 Pack
AWS861848SU	Wire Shelving 86" High 18 x 48 Starter Unit	4	4	1 - 8 Pack
AWS862436SU	Wire Shelving 86" High 24 x 36 Starter Unit	4	4	1 - 8 Pack
AWS862448SU	Wire Shelving 86" High 24 x 48 Starter Unit	4	4	1 - 8 Pack
AWS862460SU	Wire Shelving 86" High 24 x 60 Starter Unit	4	4	1 - 8 Pack
AWS862472SU	Wire Shelving 86" High 24 x 72 Starter Unit	4	4	1 - 8 Pack

# Wire Shelving Systems

MORE THAN 50 SYSTEM OPTIONS AVAILABLE



AWS184830260G

AkroBin Wire Shelving Systems			Bin Dimensions (In.)			Shelf Dimensions (In.)			Quantity	
Model No.	Description	Available Colors	L	W	H	D	L	H	Bins	Shelves
AWS143630240	Wire Shelving w/ 30240 Bins	B, R, Y, G, K, S, SC	14-3/4	8-1/4	7	14	36	74	36	4
AWS143630250	Wire Shelving w/ 30250 Bins	B, R, Y, G, K, S, SC	14-3/4	16-1/2	7	14	36	74	18	4
AWS184830260	Wire Shelving w/ 30260 Bins	B, R, Y, G, K, S, SC	18	11	10	18	48	74	24‡	6
AWS183630265	Wire Shelving w/ 30265 Bins	B, R, Y, G, S, SC	18	8-1/4	9	18	36	74	18‡	5
AWS183630270	Wire Shelving w/ 30270 Bins	B, R, Y, G, K, S, SC	18	16-1/2	11	18	36	74	9‡	5
AWS143630320	Wire Shelving w/ 30320 Bins	B	8-5/8	33	5	14	36	74	12‡	11

Bin color code: R=Red, B=Blue, Y=Yellow, G=Green, K=Black, S=Stone, SC=Clear. Specify one bin color when ordering. ‡Bonus bins included.



AWS2460M30358

1800 Series AkroBin Wire Shelving Systems			Bin Dimensions (In.)			Shelf Dimensions (In.)			Quantity	
Model No.	Description	Available Colors	L	W	H	D	L	H	Bins	Shelves
AWS2460M30358	Mobile Wire Shelving w/ 30358 Bins	Beige	20-1/2	11	7	24	60	68	30	6



AWS184830280R

Super-Size AkroBin Wire Shelving Systems			Bin Dimensions (In.)			Shelf Dimensions (In.)			Quantity	
Model No.	Description	Available Colors	L	W	H	D	L	H	Bins	Shelves
AWS184830280	Wire Shelving w/ 30280 Bins	R, B, Y	20	12-3/8	6	18	48	74	24	9
AWS184830281	Wire Shelving w/ 30281 Bins	R, B, Y	20	12-3/8	8	18	48	74	18	7
AWS184830282	Wire Shelving w/ 30282 Bins	R, B, Y	20	12-3/8	12	18	48	74	12	5
AWS184830283	Wire Shelving w/ 30283 Bins	R, B, Y	20	18	12	18	48	74	8	5
AWS1848SAB	Wire Shelving w/ 30280, 30281, 30282, 30283 Bins	B	See Above			18	48	74	4 / 3 / 4 / 4‡	6
AWS24360284	Wire Shelving w/ 30284 Bins	R, B, Y, SC	23-7/8	8-1/4	7	24	36	74	28	8
AWS24360287	Wire Shelving w/ 30287 Bins	R, B, Y, SC	23-7/8	11	10	24	36	74	16‡	6
AWS24360288	Wire Shelving w/ 30288 Bins	R, B, Y, SC	23-7/8	16-1/2	11	24	36	74	12	3
AWS24360SAB	Wire Shelving w/ 30287 & 30288 Bins	B	See Above			24	36	74	12 / 6‡	3
AWS24361288	Wire Shelving w/ 30288 Bins	R, B, Y, SC	23-7/8	16-1/2	11	24	36	63	10	3

Bin color code: R=Red, B=Blue, Y=Yellow, SC=Clear. Specify one bin color when ordering. ‡Bonus bins included.



# Wire Shelving Systems

MORE THAN 50 SYSTEM OPTIONS AVAILABLE

800.253.2467  
akro-mils.com



AWS183613014B

Stak-N-Store Wire Shelving Systems			Bin Dimensions (In.)			Shelf Dimensions (In.)			Quantity	
Model No.	Description	Available Colors	L	W	H	D	L	H	Bins	Shelves
AWS184813017	Wire Shelving w/ 13017 Bins	B	15-1/2	19-7/8	12-7/16	18	48	74	9‡	5
AWS183613014	Wire Shelving w/ 13014 Bins	GRY, B	17-1/2	10-7/8	12-1/2	18	36	74	12	5
AWS183613018	Wire Shelving w/ 13018 Bins	GRY, B, SC	17-1/2	16-1/2	12-1/2	18	36	74	8	5
AWS18365NS	Wire Shelving w/ 13014 & 13018 Bins	GRY, B, SC	See Above			18	36	74	8 / 6‡	5

Bin color code: B=Blue, GRY=Gray, SC=Clear. Specify one bin color when ordering. ‡Bonus bins included.



AWS143630120G

4" Shelf Bin Wire Shelving Systems			Bin Dimensions (In.)			Shelf Dimensions (In.)			Quantity	
Model No.	Description	Available Colors	L	W	H	D	L	H	Bins	Shelves
AWS143630120	Wire Shelving w/ 30120 Bins	B, R, Y, SC	11-5/8	4-1/8	4	14	36	74	96	12
AWS143630130	Wire Shelving w/ 30130 Bins	B, R, Y, G, SC	11-5/8	6-5/8	4	14	36	74	60	12
AWS143630150	Wire Shelving w/ 30150 Bins	B, R, Y, G, SC	11-5/8	8-3/8	4	14	36	74	48	12
AWS143630170	Wire Shelving w/ 30170 Bins	B, R, Y, G, SC	11-5/8	11-1/8	4	14	36	74	36	12
AWS183630128	Wire Shelving w/ 30128 Bins	B, R, Y, G, SC	17-7/8	4-1/8	4	18	36	74	96	12
AWS183630138	Wire Shelving w/ 30138 Bins	B, R, Y, G, SC	17-7/8	6-5/8	4	18	36	74	60	12
AWS183630158	Wire Shelving w/ 30158 Bins	B, R, Y, G, SC	17-7/8	8-3/8	4	18	36	74	48	12
AWS183630178	Wire Shelving w/ 30178 Bins	B, R, Y, G, SC	17-7/8	11-1/8	4	18	36	74	36	12
AWS244830124	Wire Shelving w/ 30124 Bins	B, R, Y, G, SC	23-5/8	4-1/8	4	24	48	74	120	12
AWS244830164	Wire Shelving w/ 30164 Bins	SC	23-5/8	6-5/8	4	24	48	74	66	12
AWS244830184	Wire Shelving w/ 30184 Bins	B, R, Y, G, SC	23-5/8	8-3/8	4	24	48	74	60‡	12
AWS244830174	Wire Shelving w/ 30174 Bins	B, R, Y, G, SC	23-5/8	11-1/8	4	24	48	74	48‡	12

Bin color code: R=Red, B=Blue, Y=Yellow, G=Green, SC=Clear. Specify one bin color when ordering. ‡Bonus bins included.



AWS183630098Y

6" ShelfMax Wire Shelving Systems			Bin Dimensions (In.)			Shelf Dimensions (In.)			Quantity	
Model No.	Description	Available Colors	L	W	H	D	L	H	Bins	Shelves
AWS183630098	Wire Shelving w/ 30098 Bins	Y	17-7/8	6-5/8	6	18	36	74	40	9

Bin color code: Y=Yellow. Specify one bin color when ordering.

# Wire Shelving Systems

MORE THAN 50 SYSTEM OPTIONS AVAILABLE

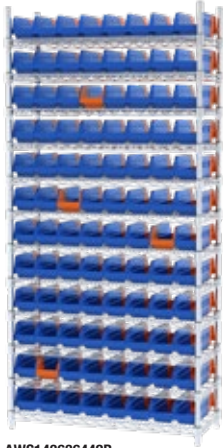

AWS143636442B

Indicator Wire Shelving Systems			Bin Dimensions (In.)			Shelf Dimensions (In.)			Quantity	
Model No.	Description	Indicator Colors	L	W	H	D	L	H	Bins	Shelves
AWS143636442B	Wire Shelving w/ 36442 Bins	Blue/Orange	11-5/8	4-1/4	4	14	36	74	96†	12
AWS143636442BK	Wire Shelving w/ 36442 Bins	Black/Red	11-5/8	4-1/4	4	14	36	74	96†	12
AWS143636462B	Wire Shelving w/ 36462 Bins	Blue/Orange	11-5/8	6-3/4	4	14	36	74	60†	12
AWS143636462BK	Wire Shelving w/ 36462 Bins	Black/Red	11-5/8	6-3/4	4	14	36	74	60†	12
AWS183636448B	Wire Shelving w/ 36448 Bins	Blue/Orange	17-7/8	4-1/8	4	18	36	74	96†	12
AWS183636448BK	Wire Shelving w/ 36448 Bins	Black/Red	17-7/8	4-1/8	4	18	36	74	96†	12
AWS183636468B	Wire Shelving w/ 36468 Bins	Blue/Orange	17-7/8	6-5/8	4	18	36	74	60†	12
AWS183636468BK	Wire Shelving w/ 36468 Bins	Black/Red	17-7/8	6-5/8	4	18	36	74	60†	12

†Bonus bins included.



AWS2460M34240

Akro-Tub Wire Shelving Systems			Bin Dimensions (In.)			Shelf Dimensions (In.)			Quantity	
Model No.	Description	Available Colors	L	W	H	D	L	H	Bins	Shelves
AWS2460M34240	Mobile Wire Shelving w/ 34240 Tubs	GRY	19	24-1/2	9-1/2	24	60	68	12	4



AWS183633166R

Akro-Grid Wire Shelving Systems			Bin Dimensions (In.)			Shelf Dimensions (In.)			Quantity	
Model No.	Description	Available Colors	L	W	H	D	L	H	Bins	Shelves
AWS183633166	Wire Shelving w/ 33166 Grids	R	16-1/2	10-7/8	6	18	36	74	24	9

Bin color code: R=Red. Specify one bin color when ordering. Dividers sold separately.

# Steel Shelving Systems

HEAVY-DUTY CUSTOMIZABLE VERTICAL STORAGE

800.253.2467  
akro-mils.com



UP TO  
**6500**  
LBS.

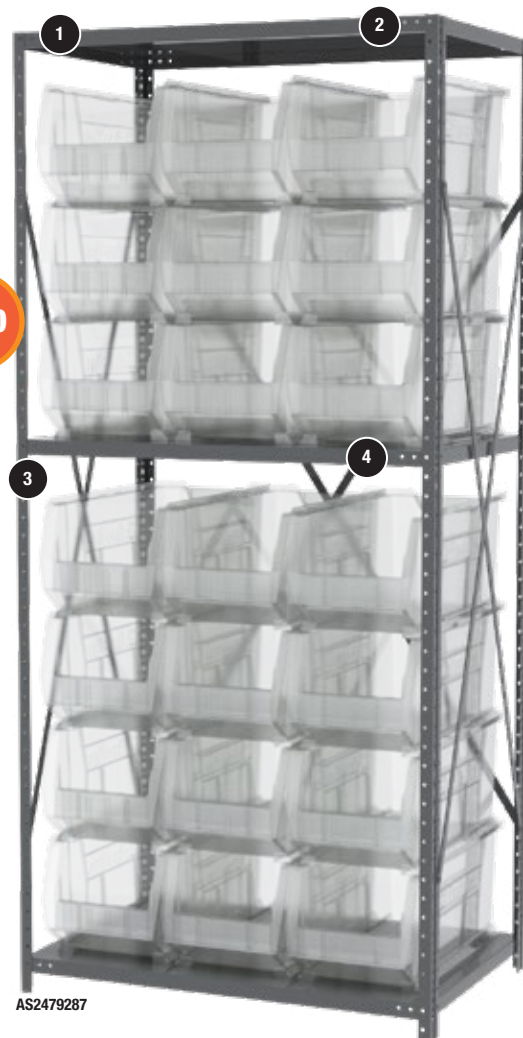

AS2479287



## FEATURES

- 1 Manufactured from high-grade, 22-gauge steel
- 2 Powder-coated finish
- 3 Quickly change shelf heights with compression clips
- 4 Adjustable shelves

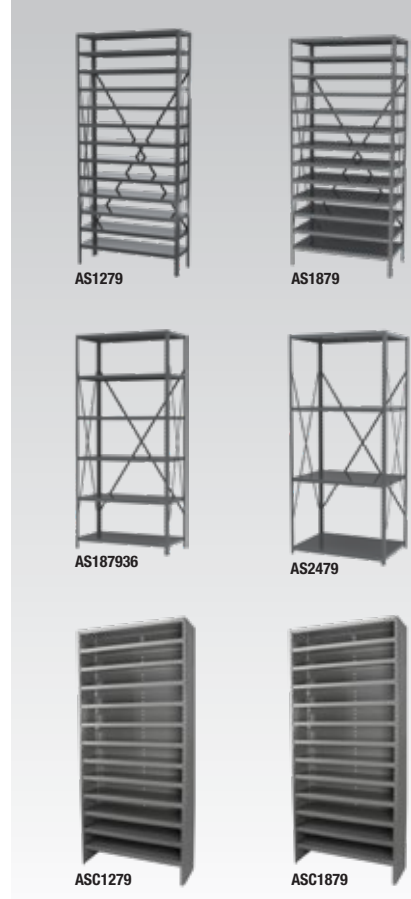

COLOR  
Gray



## PRODUCT HIGHLIGHTS

- **EFFICIENT** – Can be ordered independently or purchased with bins for a complete system
- **FUNCTIONAL** – Efficiently organize large, heavy items and improve workflow
- **VARIETY** – 3 shelf sizes available: 12" x 36", 18" x 36", 24" x 36"
- **CAPACITY** – Shelving units have 355 to 600 lb. weight capacity per shelf when assembled and installed per instructions. Per shelf weight capacity: 12" x 36": 500 lbs.; 18" x 36": 550 lbs.; 24" x 36": 550 lbs.

Steel Shelving		Shelf Dimensions (In.)			Quantity
Model Number	Description	D	L	H	Shelves
ASC1279	12" Enclosed Shelving (no AkroDrawers)	12	36	79	13
ASC1879	18" Enclosed Shelving (no AkroDrawers)	18	36	79	13
AS1279	12" Shelving (no Bins)	12	36	79	13
AS1879	18" Shelving (no Bins)	18	36	79	13
AS2479	24" Shelving (no Bins)	24	36	79	4



# Steel Shelving Systems

## HEAVY-DUTY CUSTOMIZABLE VERTICAL STORAGE



ASC1279112B

12" Enclosed Steel Shelving Systems			Bin Dimensions (In.)			Shelf Dimensions (In.)			Quantity	
Model Number	Description	AkroDrawer Colors	L	W	H	D	L	H	Drawers	Shelves
ASC1279112	Shelving with 31112 AkroDrawers	B	11-5/8	11-1/8	4-5/8	12	36	79	36	13
ASC1279142	Shelving with 31142 AkroDrawers	B, GRY	11-5/8	3-3/4	4-5/8	12	36	79	108	13
ASC1279162	Shelving with 31162 AkroDrawers	B, GRY	11-5/8	5-9/16	4-5/8	12	36	79	72	13
ASC1279182	Shelving with 31182 AkroDrawers	B, GRY	11-5/8	8-3/8	4-5/8	12	36	79	48	13
ASC1279AST	Shelving with 31142, 31162, 31182 AkroDrawers	B, GRY	See Above			12	36	79	30 / 36 / 12‡	13

Drawer color code: B=Blue, GRY=Gray. Specify drawer color when ordering. Only one color per unit. ‡Bonus drawers included.



ASC1879168B

18" Enclosed Steel Shelving Systems			Bin Dimensions (In.)			Shelf Dimensions (In.)			Quantity	
Model Number	Description	AkroDrawer Colors	L	W	H	D	L	H	Drawers	Shelves
ASC1879118	Shelving with 31118 AkroDrawers	B	17-5/8	11-1/8	4-5/8	18	36	79	36	13
ASC1879148	Shelving with 31148 AkroDrawers	B	17-5/8	3-3/4	4-5/8	18	36	79	108	13
ASC1879168	Shelving with 31168 AkroDrawers	GRY	17-5/8	5-9/16	4-5/8	18	36	79	72	13
ASC1879188	Shelving with 31188 AkroDrawers	B, GRY	17-5/8	8-3/8	4-5/8	18	36	79	48	13
ASC1879AST	Shelving with 31168, 31188 AkroDrawers	B, GRY	See Above			18	36	79	36 / 24	13

Drawer color code: B=Blue, GRY=Gray. Specify drawer color when ordering. Only one color per unit.

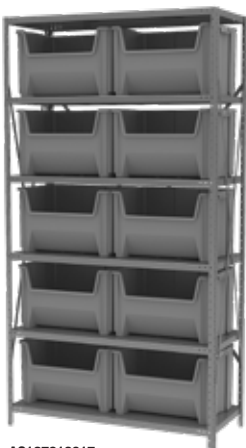

AS187913017

Stak-N-Store Steel Shelving Systems			Bin Dimensions (In.)			Shelf Dimensions (In.)			Quantity	
Model Number	Description	Available Colors	L	W	H	D	L	H	Bins	Shelves
AS187913014	36" Shelving, with 13014 Bins	B, GRY, SC	17-1/2	10-7/8	12-1/2	18	36	79	16‡	6
AS187913018	36" Shelving, with 13018 Bins	B, SC	17-1/2	16-1/2	12-1/2	18	36	79	10	6
AS1879ASORT	36" Shelving, with 13014, 13018 Bins	GRY	See Above			18	36	79	8/6‡	6
AS187913017	42" Shelving, with 13017 Bins	B, GRY, SC	15-1/4	19-7/8	12-7/16	18	42	79	12‡	6

Bin color code: B=Blue, GRY=Gray, SC=Clear. Specify one bin color when ordering. ‡Bonus bins included.



# Steel Shelving Systems

## HEAVY-DUTY CUSTOMIZABLE VERTICAL STORAGE

800.253.2467  
akro-mils.com



AS2479ASSORTR

Super-Size AkroBin Steel Shelving Systems			Bin Dimensions (In.)			Shelf Dimensions (In.)			Quantity	
Model Number	Description	Available Colors	L	W	H	D	L	H	Bins	Shelves
AS2479284	24" Shelving with 30284 Bins	B, R	23-7/8	8-1/4	7	24	36	79	32‡	9
AS2479287	24" Shelving with 30287 Bins	B, R, SC	23-7/8	11	10	24	36	79	24‡	3
AS2479288	24" Shelving with 30288 Bins	B, R, Y, SC	23-7/8	16-1/2	11	24	36	79	12	4
AS2479ASSORT	24" Shelving with 30287/30288 Bins	R, SC	See Above			24	36	79	12 / 6	3

Bin color code: R=Red, B=Blue, Y=Yellow, SC=Clear. Specify one bin color when ordering. ‡Bonus bins included.



AS1279150Y

Shelf Bin Steel Shelving Systems			Bin Dimensions (In.)			Shelf Dimensions (In.)			Quantity	
Model Number	Description	Available Colors	L	W	H	D	L	H	Bins	Shelves
AS1279110	12" Shelving with 30110 Bins	R, B, Y, G, SC	11-5/8	2-3/4	4	12	36	79	144	13
AS1279120	12" Shelving with 30120 Bins	R, B, Y, SC	11-5/8	4-1/8	4	12	36	79	96	13
AS1279130	12" Shelving with 30130 Bins	R, B, Y, G	11-5/8	6-5/8	4	12	36	79	60	13
AS1279150	12" Shelving with 30150 Bins	R, B, Y, G, SC	11-5/8	8-3/8	4	12	36	79	48	13
AS1279170	12" Shelving with 30170 Bins	R, B, G, SC	11-5/8	11-1/8	4	12	36	79	36	13
AS1879128	18" Shelving with 30128 Bins	R, B, G, SC	17-7/8	4-1/8	4	18	36	79	96	13
AS1879138	18" Shelving with 30138 Bins	R, B, Y, G, SC	17-7/8	6-5/8	4	18	36	79	60	13
AS1879158	18" Shelving with 30158 Bins	R, B, G, SC	17-7/8	8-3/8	4	18	36	79	48	13
AS1879178	18" Shelving with 30178 Bins	R, B, G, SC	17-7/8	11-1/8	4	18	36	79	36	13

Bin color code: R=Red, B=Blue, Y=Yellow, G=Green, SC=Clear. Specify one bin color when ordering.



AS2479048SC

ShelfMax Steel Shelving Systems			Bin Dimensions (In.)			Shelf Dimensions (In.)			Quantity	
Model Number	Description	Available Colors	L	W	H	D	L	H	Bins	Shelves
AS1279040	12" Steel Shelving with 30040 Bins	B, SC	11-5/8	4-1/8	6	12	36	79	80	11
AS1279090	12" Steel Shelving with 30090 Bins	B, SC	11-5/8	6-5/8	6	12	36	79	50	11
AS1279080	12" Steel Shelving with 30080 Bins	R, SC	11-5/8	8-3/8	6	12	36	79	40	11
AS1879048	18" Steel Shelving with 30048 Bins	SC	17-7/8	4-1/8	6	18	36	79	80	11
AS1879098	18" Steel Shelving with 30098 Bins	SC, Y	17-7/8	6-5/8	6	18	36	79	50	11
AS1879088	18" Steel Shelving with 30088 Bins	B	17-7/8	8-3/8	6	18	36	79	40	11
AS2479094	24" Steel Shelving with 30094 Bins	R, B, SC	23-5/8	6-5/8	6	24	36	79	50	11
AS2479084	24" Steel Shelving with 30084 Bins	R, B	23-5/8	8-3/8	6	24	36	79	42‡	11
AS2479014	24" Steel Shelving with 30014 Bins	R, B, SC	23-5/8	11-1/8	6	24	36	79	30	11

Bin color code: R=Red, B=Blue, Y=Yellow, SC=Clear. Specify one bin color when ordering.

# Steel Shelving Systems

## HEAVY-DUTY CUSTOMIZABLE VERTICAL STORAGE



AS187936442B



AS187936448BK



AS1879318Y

Indicator Bin Steel Shelving Systems			Bin Dimensions (In.)			Shelf Dimensions (In.)			Quantity	
Model Number	Description	Indicator Colors	L	W	H	D	L	H	Bins	Shelves
AS127936442B	Shelving, with 36442BLUE Indicator Bins	Blue/Orange	11-5/8	4-1/4	4	12	36	79	96	13
AS127936442BK	Shelving, with 36442BLKRED Indicator Bins	Black/Red	11-5/8	4-1/4	4	12	36	79	96	13
AS127936462B	Shelving, with 36462BLUE Indicator Bins	Blue/Orange	11-5/8	6-3/4	4	12	36	79	60	13
AS127936462BK	Shelving, with 36462BLKRED Indicator Bins	Black/Red	11-5/8	6-3/4	4	12	36	79	60	13
AS187936448BK	Shelving, with 36448BLKRED Indicator Bins	Black/Red	17-7/8	4-1/8	4	18	36	79	96	13
AS187936468B	Shelving, with 36468BLUE Indicator Bins	Blue/Orange	17-7/8	6-5/8	4	18	36	79	60	13
AS187936468BK	Shelving, with 36468BLKRED Indicator Bins	Black/Red	17-7/8	6-5/8	4	18	36	79	60	13

System Bin Steel Shelving Systems			Bin Dimensions (In.)			Shelf Dimensions (In.)			Quantity	
Model Number	Description	Available Colors	L	W	H	D	L	H	Bins	Shelves
AS1279312	12" Shelving with System Bins	B, Y	33	12	5	12	36	79	10	11
AS1879318	18" Shelving with System Bins	B, Y	33	18	5	18	36	79	10	11

Bin color code: B=Blue, Y=Yellow. Specify one bin color when ordering.

# Dollies: Steel

## HEAVY-DUTY, ALL-STEEL CONSTRUCTION

800.253.2467  
akro-mils.com



RU842HR2918



### FEATURES

- 1 Durable, powder-coated finish
- 2 All-welded 13-gauge steel or 1½" x 1½" x ⅛" angle construction
- 3 Bolt-on casters for easy replacement

#### Steel Dollies

Model No.	Description	Capacity (lbs.)	Caster Type	Caster Size (In.)	Deck Height (Inches)
RU842HR2918	Solid Steel Dolly - Lips Up	400	Polyolefin	2 x 1-1/4	3
RU843HR1420	Solid Steel Dolly - Lips Up	900	Polyolefin	3 x 1-1/4	5-1/2

COLOR  
Gray



RU843HR1420 with 39120

Attached Lid Container Steel Dollies				Dimensions (In.)			Capacity/Quantity		
Model No.	Bin Compatibility			L	W	H	Casters	Ctn. Qty.	Capacity
RU843HR1420	39085, 39120, 39170, 66486CLDBL, 66486FILEB, 66497CLDGN			19-7/8	14-1/4	5-1/8	3" Polyolefin	1	900 lbs.

Bins sold separately, see page 18-19.



# VERSA/Deck™

## VERSATILE STRUCTURAL FOAM PLATFORM TRUCK



R90182A1412



### FEATURES

- 1 Non-skid structural foam deck is easy-to-clean and won't rot, chip or rust
- 2 Jam Bolts, standard on all models, hold handles in place
- 3 4 molded-in tie-down slots secure items during transport
- 4 Steel reinforcements provide durability and a weight capacity of up to 2,000 lbs.
- 5 Cart handles feature a durable, powder-coated finish, and are removable for convenient shipping and storage

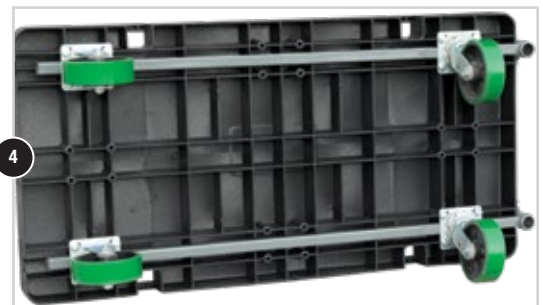
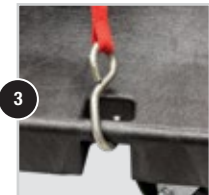

### PRODUCT HIGHLIGHTS

- **DURABLE** – HDPE molded structural foam with steel reinforcement
- **CAPACITY** – Up to 2,000 lb. weight capacity

**COLOR**  
Black/Gray



VERSA/Deck Platform Truck				
Model No.	Deck Size	Handle Type	Caster Type	Caster Size (In.)
R90182A1411	24 x 48	Open	Pro-Tech Polyurethane	6
R90182A1412	24 x 48	Crossbar	Pro-Tech Polyurethane	6
R90185A1412	24 x 48	Crossbar	Pro-Tech Polyurethane	6
V9010093A	24 x 48	NONE	–	–
V90182A1412	24 x 48	Crossbar	Pro-Tech Polyurethane	6
R90282A1011	30 x 60	Open	Pro-Tech Polyurethane	6
R90282A1012	30 x 60	Crossbar	Pro-Tech Polyurethane	6
R902XXA1011	30 x 60	Open	–	–

Ships in carton unassembled.

#### Handle Styles:

"11" Open Swayback



"12" Crossbar Swayback



#### Caster Style:

Pro-Tech





# ULTRA/Deck™

## HEAVY-DUTY STRUCTURAL FOAM PLATFORM TRUCK

800.253.2467  
akro-mils.com



# ULTRA/Deck™



V901849392412AM



## FEATURES

- 1 Sturdy, easy-to-clean, non-skid structural foam deck resists most chemicals and damage from long-term weather exposure
- 2 The ULTRA/Deck is heavy-duty! Steel reinforcements and extra structural foam ribs under the deck add strength and stability for your toughest loads
- 3 Cart handles feature a durable, powder-coated finish, and are removable for convenient shipping and storage

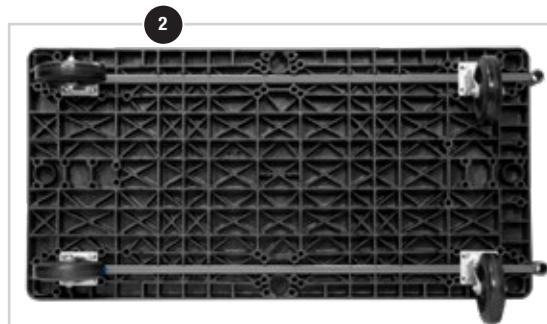

## PRODUCT HIGHLIGHTS

- **RUGGED** – HDPE molded structural foam withstands the toughest loads in most environments
- **CAPACITY** – Caster options allow up to 3,000 lb. weight capacity

**COLOR**  
Black/Gray



ULTRA/Deck Platform Truck				
Model No.	Deck Size	Handle Type	Caster Type	Caster Size (In.)
RB4544EGJB	24 x 48	Open	–	–
V90166A1411JB*	24 x 48	Open	Pro-Tech Polyurethane	6
V901849392412AM	24 x 48	Crossbar	Polyolefin	8
V90262A1011	30 x 60	Open	Polyolefin	8
V902849393012AM	30 x 60	Crossbar	Polyolefin	8

Ships in carton unassembled. \*Ships fully assembled.

### Handle Styles:

“11” Open Swayback



“12” Crossbar Swayback



### Caster Styles:

Polyolefin



Pro-Tech





# ProCart™

## VERSATILE STRUCTURAL FOAM UTILITY CART



**COLOR**  
Gray



### FEATURES

- 1 Hinged side gates on both shelves flip up or down to easily convert the ProCart to a flat-top or box-top cart
- 2 Deep, molded-in compartments keep items within reach (Only large cart has cup holder)
- 3 Comfortable, full-width handle gives complete handling control
- 4 Smooth, rounded corners and edges
- 5 Toe-touch, locking rear swivel wheels
- 6 Durable, non-marking, polyurethane on polyolefin 5" wheels: 1.75" x 3" caster bolt pattern
- 7 I-beam post makes loading and unloading oversized boxes on the lower shelf easy
- 8 Optional rail systems (sold separately) allow AkroBins® or 19-Series Steel Cabinets to hang on carts

### PRODUCT HIGHLIGHTS

- **VERSATILE** – All-purpose utility cart for the assembly line, warehouse or wherever you need portable storage
- **DURABLE** – High-density structural foam construction is dent-resistant, rust-proof and never needs painting
- **CAPACITY** – 400 lb. maximum cart load. 200 lb. capacity per top and bottom shelf
- **ASSEMBLY** – Light assembly required
- **VARIETY** – 2 sizes



### ProCart™

ProCart		Dimensions (In.)			
Model No.	Description	L	W	H	Ctn. Qty.
30936	Large Cart	45-5/8	24	34-3/4	1
30930	Small Cart	41-1/2	19	34-3/4	1

#### ProCart Rail Kits

Model No.	Description
30900	Small Cart 9-Rail System
30906	Large Cart 9-Rail System

Easy assembly – requires Phillips screwdriver and rubber mallet.

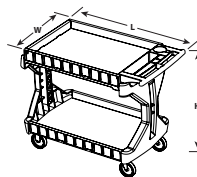

#### AkroBins Ordering Information

To create a customized ProCart with AkroBins, use the chart below to determine the quantity of bins that will fit your ProCart. Carts, rail kits and bins must be ordered separately. When ordering, please specify bin color. See pages 4-5 for more AkroBin information. See page 38 for 19-Series Steel Cabinet information.

Use this chart when ordering one size AkroBins and 19-Series Cabinets for your ProCart

Bin Model No. Bin Dim. L x W x H	30210 5-3/8 x 4-1/8 x 3	30220 7-3/8 x 4-1/8 x 3	30224 10-7/8 x 4-3/16 x 4	30230 10-7/8 x 5-1/2 x 5	30234 14-3/4 x 5-1/2 x 5	30235 10-3/8 x 11 x 5	30239 10-3/4 x 8-1/4 x 7	30240 14-3/4 x 8-1/4 x 7	30250 14-3/4 x 16-1/2 x 7	30255 10-3/4 x 16-1/2 x 5	30320 8-5/8 x 33 x 5	19-Series Cabinet*
30936 Large Cart	80	80	48	36	36	18	16	16	8	12	6	4
30930 Small Cart	70	70	42	30	–	12	12	–	–	–	–	2

\*Requires 98400 Suspension Straps for hanging.

#### RELATED PRODUCTS

Increase the benefits of your ProCart with:



4-5 AkroBins



22 Akro-Grids



38 19-Series Steel Cabinets



# Hand Trucks

## HEAVY-DUTY : GAS CYLINDER

### Heavy-Duty Hand Trucks



- **HEAVY-DUTY** – Hand trucks ideal for all types of loads
- **FRAME** – 1" OD structural pipe frame, 13-gauge steel
- **NOSE PLATE** – 7-gauge steel
- **WHEELS** – Two-position bracket fits 8" or 10" wheels

COLOR  
Gray



Heavy-Duty Hand Trucks - Dual Loop				Dimensions (In.)	
Model No.	Wheel Type	Wheel Size (In.)	Nose Plate	H	W
R4510SP210X14	Semi-Pneumatic	10	10 x 14	53	20



### 4-Wheel Gas Cylinder Trucks



- **HEAVY-DUTY** – Designed to handle 330 cu. ft. cylinders
- **FRAME** – 1" OD structural pipe frame, 13-gauge wall
- **NOSE PLATE** – Standard 7" x 14" size, 7-gauge steel
- **WHEELS** – 4" polyolefin swivel casters

COLOR  
Green



4-Wheel Gas Cylinder Trucks				
Model No.	Truck Type	Wheel Type	Wheel Size (In.)	Base Plate
RGTS10FP	Single	Full Pneumatic	10 x 3-1/2	14" W x 6" D, OAH – 45" 1143
RGTS10SP	Single	Semi-Pneumatic	10 x 2-3/4	14" W x 6" D, OAH – 45" 1143
RGTD10SP	Dual	Semi-Pneumatic	10 x 2-3/4	29" W x 6" D, OAH – 45" 1143

Single holds up to #4 (130 cu. ft.) acetylene or 336 cu ft high-pressure cylinder. Double holds up to two #4 (130 cu ft) acetylene or 251 cu ft high-pressure cylinders.



RGTS10FP



RGTD10SP





# Pail Truck

SPECIALTY HAND TRUCK FOR 5 GALLON PAILS

800.253.2467  
akro-mils.com



## PRODUCT HIGHLIGHTS

- **FUNCTIONAL** – Multi-purpose hand truck for carting 5-gallon pails
- **CAPACITY** – Holds 4 pails, up to 300 lbs. weight capacity

**COLORS**  
Gray, Red



### Pail Truck

Model No.	Description	Wheel Type	Wheel Size (In.)	Overall Height (In.)	Overall Width (In.)
RPT4010SP	Gray Pail Truck	Semi-Pneumatic	10	55-1/2	18-1/2
RPT4010SPRED	Red Pail Truck	Semi-Pneumatic	10	55-1/2	18-1/2



# Akro-Tilt Trucks

BULK HANDLING & WASTE TRANSPORT SYSTEMS



UP TO  
2000  
LBS.



77405



77410



77505



77510



77610



77710



77810



## FEATURES

- 1 Fully assembled units nest for shipping, saving on freight and space†
- 2 Wheel base and heavy-duty caster combination provides easy maneuverability even with heavy loads
- 3 Optional forklift channels allow fully loaded Akro-Tilt Trucks to be moved and maneuvered by lift trucks, saving time, money and effort
- 4 Powder-coated tubular frame, constructed of 1.05" O.D. x 13-gauge and 1.3125" O.D. x 13-gauge wall tubes, extends under top rim for added strength
- 5 Fully welded, reinforced frame is optimized for automatic dumper applications

COLOR  
Gray/Gray



MADE IN THE USA

# Akro-Tilt Trucks

BULK HANDLING & WASTE TRANSPORT SYSTEMS

800.253.2467  
akro-mils.com



Akro-Tilts have 13-gauge metal lift handles which work with tilt cart dumpers.

Akro-Tilt Trucks			Dimensions (In.)			Wheels		Capacity			
Model No.	Model No. with Fork Channels	Description	W	D	H	Wheel Diameter	Wheel Type*	Gal.	Cu. Yds.	Cu. Ft.	Load Rating
77405GREY	77405FGREY	Medium-Duty 100	29	59	38	12	SP	100	1/2	13.5	600 lbs.
77410GREY	77410FGREY	Medium-Duty 200	33	68	42	12	SP	200	1	27	600 lbs.
77505GREY	77505FGREY	Heavy-Duty 100	29	59	38	10	MR	100	1/2	13.5	1000 lbs.
77510GREY	77510FGREY	Heavy-Duty 200	33	68	42	10	MR	200	1	27	1000 lbs.
77610GREY	77610FGREY	Super-Heavy-Duty 200	33	68	42	12	MR	200	1	27	2000 lbs.
77710GREY	77710FGREY	Heavy-Duty 300	38	85	50	12	MR	300	1-1/2	40.5	2000 lbs.
77810GREY	77810FGREY	Heavy-Duty 400	48	86	50	12	MR	400	2	54	2000 lbs.

\*SP = Semi-Pneumatic MR = Mold-On Rubber †Forklift channel option eliminates nestability of units.



# Akro-Carts

BULK HANDLING & WASTE TRANSPORT SYSTEMS



UP TO  
**450**  
LBS.



76460



76491



76590

## COLORS

Blue/Black, Green/Black Gray/Black



## FEATURES

- 1 Thick, rugged tub walls
- 2 Medium-duty and heavy-duty styles
- 3 Wide mouth and low profile for easy loading
- 4 Swivel caster for easy maneuverability and handling
- 5 Latch bars extend around the frame for easy loading
- 6 Heavy-duty piano hinge allows lid to be propped open during use



Akro-Carts			Dimensions (In.)							
Model No. without Lid*	Model No. with Lid	Description	W	D	H	Wheel Size	Wheel Type	Caster	Frame	Load Rating
76460	76461	Medium-Duty 60 Gal. Cap.	30-1/2	48	33-1/2	12" x 2"	Solid Rubber	3 x 1-1/4 Thermoplastic	1" O.D. x 16 ga. powder-coated w/ 5/8" solid axle	300 lbs.
76490	76491	Medium-Duty 90 Gal. Cap.	30-1/2	47	39-1/2	12" x 2"	Solid Rubber	3 x 1-1/4 Thermoplastic	1" O.D. x 16 ga. powder-coated w/ 5/8" solid axle	350 lbs.
76590	76591	Heavy-Duty 90 Gal. Cap.	30-1/2	47	39-1/2	10" x 2-3/4"	Semi-Pneumatic	4 x 2 Mold-on Rubber	1.05" O.D. x 13 ga. powder-coated w/ 5/8" solid axle	450 lbs.

Please specify colors when ordering. For additional colors, call us. \*Carts without lids cannot have lids added after production. Single units are shipped completely assembled. When multiple units are ordered, lids are shipped separately and require assembly.



# Caster Information

## HIGH-QUALITY WHEEL & CASTER OPTIONS

800.253.2467  
akro-mils.com



### CASTER SELECTION GUIDE

Standard Casters & Wheels	Description	Image	Performance Indicators													
			Floor Surface				Floor Conditions				Other Factors to Consider					
<b>Mold-On Rubber</b>	Designed for medium to heavy loads, these wheels with cushioned rubber tread are quiet and provide good floor protection.		■	⊗	■	▣	⊗	⊗	▣	▣	■	■	■	▣	▣	⊗
<b>Polyolefin</b>	A heavy-duty, lightweight, non-marking plastic wheel that resists most chemicals and oils, and has excellent impact resistance.		⊗	▣	■	⊗	■	▣	■	▣	▣	⊗	■	▣	■	⊗
<b>Polyurethane</b>	Chemically bonded to a metal core, polyurethane wheels are more durable than other materials, deliver excellent mobility, a cushioned ride and long life when subjected to heavy loads.		■	▣	■	▣	▣	▣	▣	■	■	▣	■	■	▣	⊗
<b>Pneumatic, Semi-Pneumatic</b>	Air-filled for excellent shock protection, floor protection and easy operation over rough surfaces.		■	⊗	■	⊗	⊗	⊗	▣	▣	■	■	■	▣	⊗	⊗
<b>Pro-Tech Polyurethane</b>	Maintenance-free precision wheel bearings, non-marking polyurethane tread on polypropylene core.		■	▣	■	▣	■	▣	▣	■	■	▣	■	■	▣	⊗
<b>Thermoplastic, Gray Non-Marking Rubber</b>	Soft gray rubber wheel provides excellent floor protection and a cushioned ride while resisting chemicals, acids, oils and caustic substances.		■	▣	■	▣	■	▣	■	■	■	■	■	▣	▣	⊗

■ = Excellent    ▣ = Ok    ⊗ = Not Recommended

Caster	Caster Weight Capacities (Lbs.)*						
	10	8	6	5	4	3.5	3
<b>Mold-On Rubber, Blue Elastic</b>	3200	2200	1600	1400	1200	-	-
<b>Pneumatic</b>	1500	1200	-	-	-	-	-
<b>Polyolefin</b>	-	3200	2600	1800	1000	-	900
<b>Polyurethane</b>	8800	4200	3600	3600	-	-	-
<b>Pro-Tech Polyurethane</b>	-	-	3000	-	-	-	-
<b>Semi-Pneumatic</b>	2200	-	-	-	-	-	-
<b>Thermoplastic</b>	-	600 <sup>†</sup>	-	400 <sup>†</sup>	-	-	-
<b>Gray Non-Marking Rubber</b>	-	-	2000	-	-	1000	-

\*Based on evenly distributed load on 4 casters. †Light-duty.

### IT'S ALL ABOUT THE WHEEL



Other 3" polyolefin caster    Akro-Mils 3" polyolefin caster

Those that depend upon platform trucks, carts and dollies to do their jobs understand that the right caster makes ALL the difference.

For example, not all 3" polyolefin casters are built the same, even if they look similar. Akro-Mils gives you more:

- ➔ **Double Ball Race vs. Single Ball Race.**  
This provides better rotation and control.
- ➔ **Sealed Wheel Hub Ball Bearings vs. Plain Bore.**  
This provides better overall roll ability.
- ➔ **More Structural Wheel Profile.**  
Allows the wheel to be stronger under impact.
- ➔ **Heat-Treated Plate Raceway vs. Non Heat-Treated.**  
This provides better support under load conditions.

GET MORE OF WHAT YOU PAID FOR WITH AKRO-MILS!

# Product Index

## MATERIAL HANDLING : STORAGE : ORGANIZATION PRODUCTS

05705.....	34	30161.....	29	30635GY .....	30	35231.....	21	40292.....	9
05805.....	34	30164.....	12	30636.....	29	35240.....	21	40321.....	5
05905.....	34	30170.....	12	30651.....	29	35241.....	21	40348.....	7
06118.....	35	30174.....	12	30653.....	29	35300.....	21	40358.....	7
06702.....	37	30178.....	12	30655.....	29	35301.....	21	40410.....	11
06703.....	37	30184.....	12	30658.....	29	36442BLKRED .....	14	40416.....	38
06704.....	37	30210.....	5	30661.....	29	36442BLUE .....	14	40442.....	14
06705.....	37	30210ESD .....	7	30661DOLLYGY.....	29	36448BLKRED .....	14	40462.....	14
06706.....	37	30211CRY .....	5	30676.....	29	36448BLUE .....	14	40715.....	38
09185BLUE .....	35	30220.....	5	30716BLACK .....	16	36462BLKRED .....	14	40716.....	41
09514.....	35	30220ESD .....	7	30718BLACK .....	16	36462BLUE .....	14	40717.....	41
09912.....	35	30221CRY .....	5	30776BLACK .....	16	36468BLKRED .....	14	40909.....	38
10116.....	41	30224.....	5	30778BLACK .....	16	36468BLUE .....	14	41105.....	23
10124.....	41	30225CRY .....	5	30796BLACK .....	16	37208.....	25	41162.....	23
10126.....	41	30230.....	5	30812.....	27	37278.....	25	41164.....	23
10144.....	41	30230ESD .....	7	30900.....	59	37288.....	25	41165.....	23
10164.....	41	30231CRY .....	5	30906.....	59	37608.....	25	41166.....	23
13014.....	10	30234.....	5	30930.....	59	37612.....	25	41168.....	23
13017.....	10	30235.....	5	30936.....	59	37616.....	25	41220.....	23
13018.....	10	30235ESD .....	7	31112.....	15	37672.....	25	41222.....	23
19228.....	38	30236CRY .....	5	31118.....	15	37676.....	25	41223.....	23
19320.....	38	30237.....	5	31142.....	15	37678.....	25	41224.....	23
19416.....	38	30239.....	5	31148.....	15	37682.....	25	41226.....	23
19715.....	38	30240.....	5	31162.....	15	37686.....	25	41228.....	23
19909.....	38	30240ESD .....	7	31168.....	15	37688.....	25	41230.....	5
20228.....	38	30250.....	5	31182.....	15	38004RED .....	24	41250.....	5
20320.....	38	30255.....	5	31188.....	15	38008YEL .....	24	41270.....	5
20416.....	38	30260.....	5	33011.....	23	38358GRY .....	24	41284.....	9
20715.....	38	30265.....	5	33023.....	23	39085.....	18	41286.....	9
20909.....	38	30270.....	5	33061.....	23	39120.....	18	41287.....	9
29300.....	11, 12	30280.....	9	33105.....	23	39160.....	18	41288.....	9
29301.....	5, 11, 13	30281.....	9	33162.....	23	39170.....	18	41289.....	9
29302.....	5, 11	30282.....	9	33164.....	23	39175.....	18	41410.....	15
29306.....	11, 46	30283.....	9	33165.....	23	39280.....	18	41440.....	15
29308.....	11, 46	30284.....	9	33166.....	23	40020.....	13	41460.....	15
30008.....	27	30286.....	9	33168.....	23	40030.....	13	41480.....	15
30014.....	13	30287.....	9	33220.....	23	40040.....	13	42105.....	23
30016.....	27, 39	30288.....	9	33222.....	23	40120.....	12, 14	42162.....	23
30040.....	13	30289.....	9	33223.....	23	40130.....	12, 14	42164.....	23
30048.....	13	30290.....	9	33224.....	23	40150.....	12	42165.....	23
30080.....	13	30292.....	9	33226.....	23	40170.....	12	42166.....	23
30084.....	13	30293.....	9	33228.....	23	40210.....	5	42168.....	23
30088.....	13	30312.....	16	34240.....	17	40220.....	5	42220.....	23
30090.....	13	30318.....	16	34301.....	17	40224.....	5	42222.....	23
30094.....	13	30320.....	5	34303.....	17	40228.....	38	42223.....	23
30098.....	13	30348BEIGE .....	7	34304.....	17	40230.....	5	42224.....	23
30101.....	12	30358BEIGE .....	7	34305.....	17	40234.....	5	42226.....	23
30102.....	12	30424.....	27, 39	35010.....	21, 23	40239.....	5	42228.....	23
30110.....	12	305A1 .....	6	35180.....	21	40245.....	5	48300.....	24
30118.....	29	305A2 .....	6	35181.....	21	40260.....	5	48301.....	24
30120.....	12	305A3 .....	6	35185.....	21	40265.....	5	66486CLDBL .....	19
30124.....	12	305A4 .....	6	35190.....	21	40270.....	5	66486FILEB.....	19
30128.....	12	305A5 .....	6	35191.....	21	40280.....	9	66497CLDGN.....	19
30130.....	12	305A6 .....	6	35195.....	21	40281.....	9	76460.....	64
30138.....	12	305B1 .....	6	35200.....	21	40282.....	9	76461.....	64
30148.....	27	305B2 .....	6	35201.....	21	40286.....	9	76490.....	64
30150.....	12	30618.....	29	35225.....	21	40287.....	9	76491.....	64
30158.....	12	30632.....	29	35230.....	21	40290.....	9	76590.....	64

# Product Index

MATERIAL HANDLING : STORAGE : ORGANIZATION PRODUCTS

800.253.2467  
akro-mils.com

76591.....	64	APRS150.....	33	AWFOOTLEVEL4PK.....	46	AWS861236SU.....	47	R90185A1412.....	56
77405FGREY.....	63	AS1279.....	51	AWFOOTPLATE4PK.....	46	AWS861436SU.....	47	R90282A1011.....	56
77405GREY.....	63	AS1879.....	51	AWP54UPRIGHT.....	45	AWS861824SU.....	47	R90282A1012.....	56
77410FGREY.....	63	AS1879ASORT.....	52	AWP63UPRIGHT.....	45	AWS861830SU.....	47	RB4544EGJB.....	57
77410GREY.....	63	AS2479.....	51	AWP74UPRIGHT.....	45	AWS861836SU.....	47	RGTD10SP.....	60
77505FGREY.....	63	AS2479ASSORT.....	53	AWP86UPRIGHT.....	45	AWS861848SU.....	47	RGTS10FP.....	60
77505GREY.....	63	AS1279040.....	53	AWPCAST4.....	46	AWS862436SU.....	47	RGTS10SP.....	60
77510FGREY.....	63	AS1279080.....	53	AWPCAST5Y.....	46	AWS862448SU.....	47	RPT4010SP.....	61
77510GREY.....	63	AS1279090.....	53	AWS1224SHELF.....	45	AWS862460SU.....	47	RPT4010SPRED.....	61
77610FGREY.....	63	AS1279110.....	53	AWS1236SHELF.....	45	AWS862472SU.....	47	RU842HR2918.....	55
77610GREY.....	63	AS1279120.....	53	AWS1436SHELF.....	45	AWS24360284.....	48	RU843HR1420.....	18 55
77710FGREY.....	63	AS1279130.....	53	AWS1824SHELF.....	45	AWS24360287.....	48		
77710GREY.....	63	AS1279150.....	53	AWS1830SHELF.....	45	AWS24360288.....	48	<b>V</b>	
77810FGREY.....	63	AS1279170.....	53	AWS1836SHELF.....	45	AWS24361288.....	48	V90166A1411JB.....	57
77810GREY.....	63	AS1279312.....	54	AWS1836SNS.....	49	AWS143630120.....	49	V90182A1412.....	56
96352A.....	34	AS1879048.....	53	AWS1848SAB.....	48	AWS143630130.....	49	V90262A1011.....	57
96352B.....	34	AS1879088.....	53	AWS1848SHELF.....	45	AWS143630150.....	49	V9010093A.....	56
98325.....	39	AS1879098.....	53	AWS2436SHELF.....	45	AWS143630170.....	49	V901849392412AM.....	57
98400.....	27, 38, 39	AS1879128.....	53	AWS2448SHELF.....	45	AWS143630240.....	48	V902849393012AM.....	57
98600.....	31	AS1879138.....	53	AWS2460M30358.....	48	AWS143630250.....	48		
98636.....	31	AS1879158.....	53	AWS2460M34240.....	50	AWS143630320.....	48		
30016220SC.....	27	AS1879178.....	53	AWS2460SHELF.....	45	AWS143636442B.....	50		
30016240SC.....	27	AS1879318.....	54	AWS2472SHELF.....	45	AWS143636442BK.....	50		
		AS2479014.....	53	AWS24360SAB.....	48	AWS143636462B.....	50		
<b>A</b>		AS2479084.....	53	AWS541224SU.....	47	AWS143636462BK.....	50		
AC3618.....	43	AS2479094.....	53	AWS541236SU.....	47	AWS183613014.....	49		
AC3618PUT.....	43	AS2479284.....	53	AWS541436SU.....	47	AWS183613018.....	49		
AC3618QV.....	44	AS2479287.....	53	AWS541824SU.....	47	AWS183630098.....	49		
AC3618QV240.....	44	AS2479288.....	53	AWS541830SU.....	47	AWS183630128.....	49		
AC3618QV250.....	44	AS127936442B.....	54	AWS541836SU.....	47	AWS183630138.....	49		
AC3618QV2503S.....	44	AS127936442BK.....	54	AWS541848SU.....	47	AWS183630158.....	49		
AC3618QVGRY.....	44	AS127936462B.....	54	AWS542436SU.....	47	AWS183630178.....	49		
AC3618SHELF4PKPUT..	43	AS127936462BK.....	54	AWS542448SU.....	47	AWS183630265.....	48		
AC3618Y.....	43	AS187913014.....	52	AWS542460SU.....	47	AWS183630270.....	48		
AC3618YPUT.....	43	AS187913017.....	52	AWS542472SU.....	47	AWS183633166.....	50		
AC3624.....	43	AS187913018.....	52	AWS631224SU.....	47	AWS183636448B.....	50		
AC3624SHELF3PK.....	43	AS187936448BK.....	54	AWS631236SU.....	47	AWS183636448BK.....	50		
AC3624Y.....	43	AS187936468B.....	54	AWS631436SU.....	47	AWS183636468B.....	50		
AC3624Y3AS.....	43	AS187936468BK.....	54	AWS631824SU.....	47	AWS183636468BK.....	50		
AC36243AS.....	43	ASC1279.....	51	AWS631830SU.....	47	AWS184813017.....	49		
AC803618M26.....	43	ASC1279AST.....	52	AWS631836SU.....	47	AWS184830260.....	48		
AC803624M26.....	43	ASC1879.....	51	AWS631848SU.....	47	AWS184830280.....	48		
ACKEY.....	43	ASC1879AST.....	52	AWS632436SU.....	47	AWS184830281.....	48		
ACKEYF.....	43	ASC1279112.....	52	AWS632448SU.....	47	AWS184830282.....	48		
APRBENCH.....	32	ASC1279142.....	52	AWS632460SU.....	47	AWS184830283.....	48		
APRBENCH120.....	32	ASC1279162.....	52	AWS632472SU.....	47	AWS244830124.....	49		
APRBENCH150.....	32	ASC1279182.....	52	AWS741224SU.....	47	AWS244830164.....	49		
APRD.....	32	ASC1879118.....	52	AWS741236SU.....	47	AWS244830174.....	49		
APRD18.....	32	ASC1879148.....	52	AWS741436SU.....	47	AWS244830184.....	49		
APRD18MOBILE.....	32	ASC1879168.....	52	AWS741824SU.....	47	AWSHOOK8PK.....	46		
APRD080.....	33	ASC1879188.....	52	AWS741830SU.....	47				
APRD110.....	33	AW1236LINER.....	46	AWS741836SU.....	47				
APRD120.....	33	AW1836LINER.....	46	AWS741848SU.....	47				
APRDMOBILE.....	32	AW1848LINER.....	46	AWS742436SU.....	47				
APRS.....	32	AW2460LINER.....	46	AWS742448SU.....	47				
APRS18.....	32	AW2472LINER.....	46	AWS742460SU.....	47				
APRS080.....	33	AWCLIP4PK.....	46	AWS742472SU.....	47				
APRS110.....	33	AWDONUT.....	46	AWS861224SU.....	47				

# Akro-Mils <sup>Materials...</sup>Handled!™

Akro-Mils products handle your toughest challenges! Our industry-leading line of plastic and metal storage, organization, transport and material handling products are designed for industrial, medical, retail and home settings.

Call Akro-Mils Customer Service at **800-253-2467** or visit **akro-mils.com** to find out more.

Follow us:   

## Myers Industries Material Handling Group

**AKRO-MILS : AMERI-KART : BUCKHORN : JAMCO : SCEPTER**

Our sister companies in Myers Industries, Inc.'s Material Handling Segment include:



Ameri-Kart is an industry-leading manufacturer of custom molded polymer products for the recreational vehicle, marine, industrial, heavy truck and healthcare markets.  
**ameri-kart.com**



Buckhorn offers a broad selection of bulk and hand-held containers, pallets and transport products – helping customers in the manufacturing, distribution and food industries.  
**buckhorninc.com**



Jamco Products offers a wide selection of safety flammable cabinets, welded steel service carts, platform trucks, mobile work centers, racks and cabinets for plastic bins, and more.  
**jamcoproducts.com**



Scepter designs and manufactures molded plastic material handling products for marine, military, industrial and consumer markets.  
**scepter.com**



1293 South Main Street, Akron, Ohio 44301 | tel: 800.253.2467 | inquiry@akro-mils.com | akro-mils.com

In Canada: Ak-West, Inc. | tel: 877.979.8940 | fax: 403.225.1696 | sales@ak-westinc.com | ak-westinc.com